

## Technical Specification

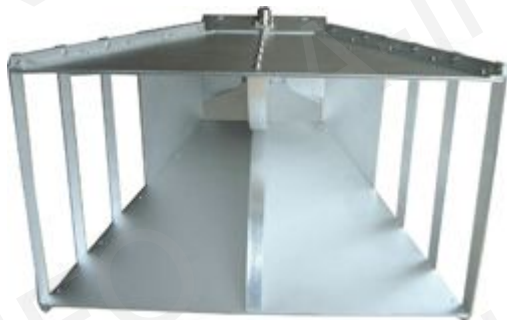

Frequency Range(GHz)	0.5 - 3.0
Gain(dB)	11 Typ.
Polarization	Linear
VSWR	2.0:1 Typ.
Connector	N-Female
Power Handling(W)	500 Max. CW
Size(mm)	440 x 290 x 350
Net Weight(Kg)	6.8 Around

## Outline Drawing (Size: mm)

N Type Female Output

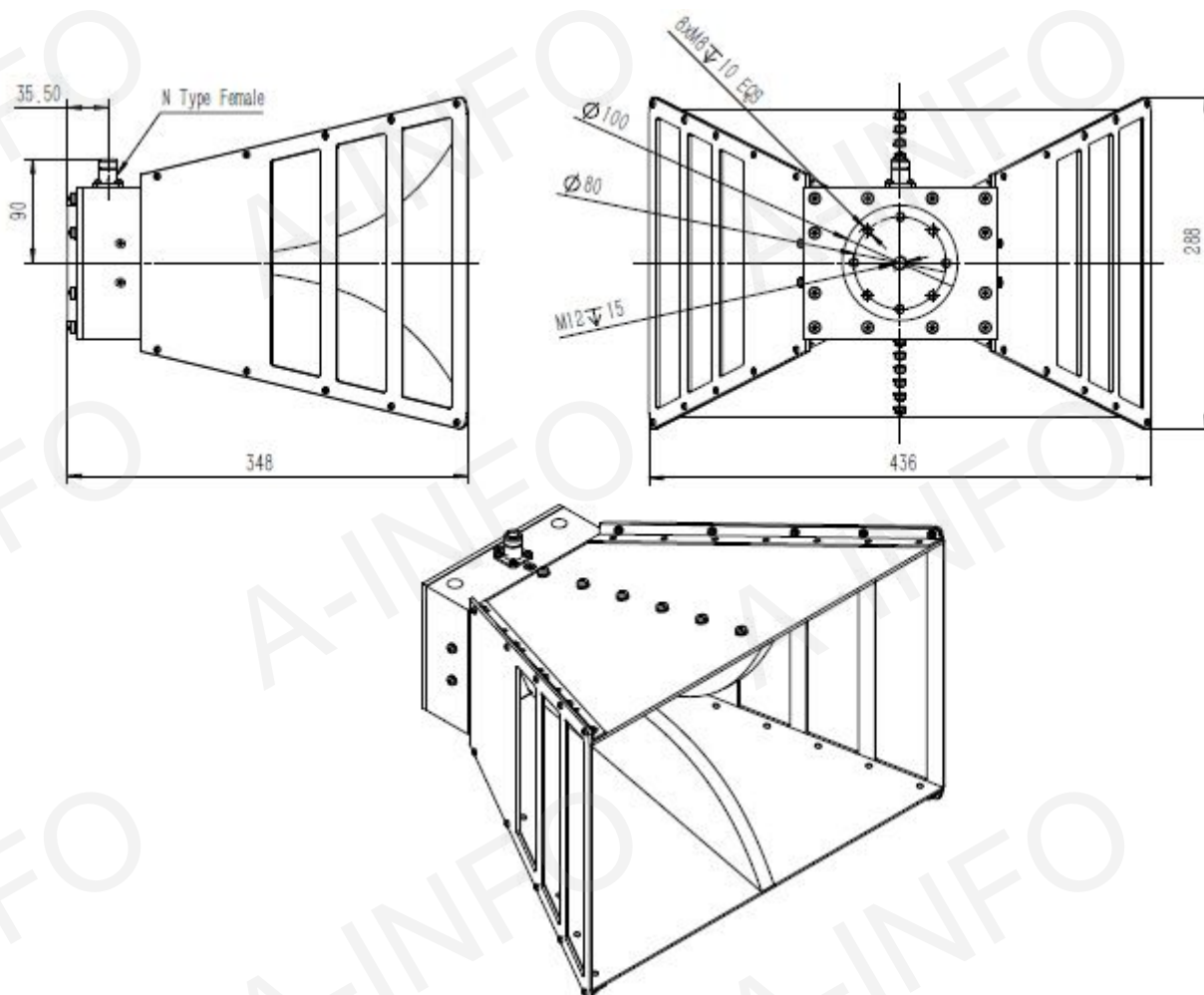

N Type Female Output with L type mounting bracket

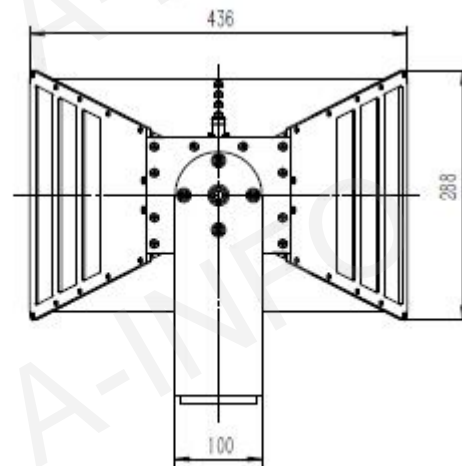
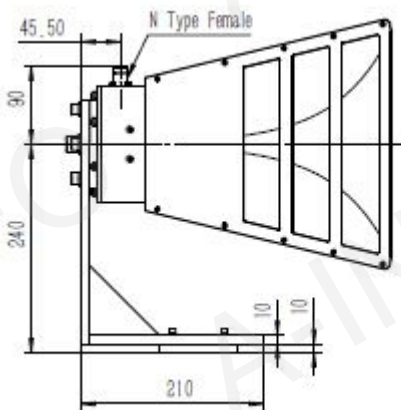
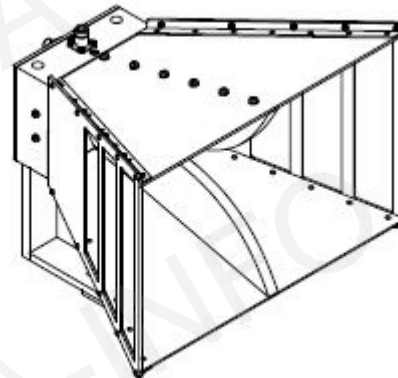
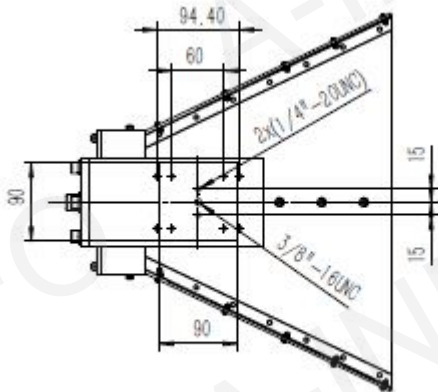

## Test Results

### 1. Gain

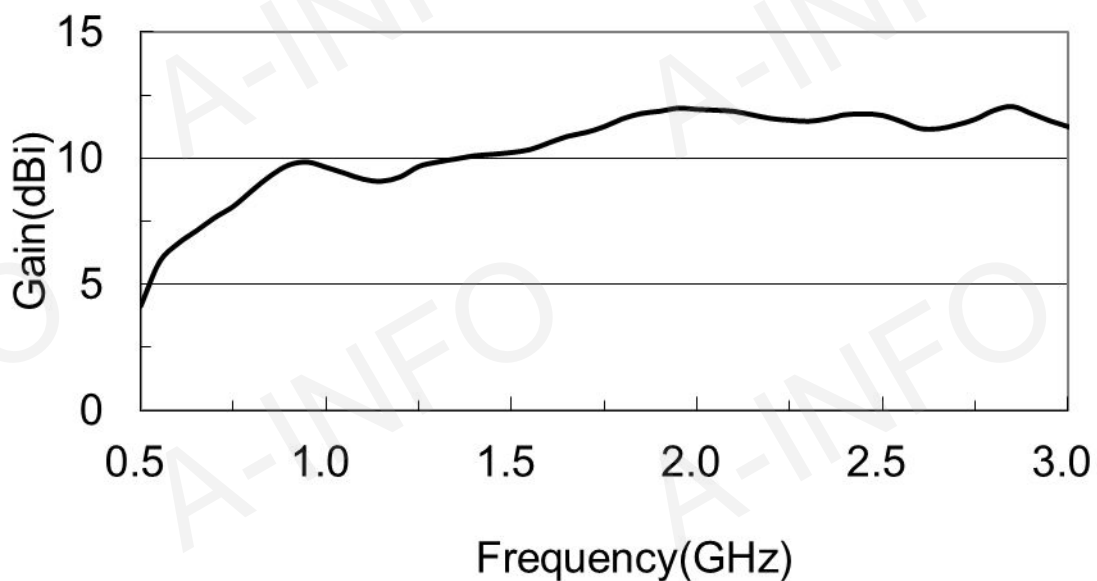

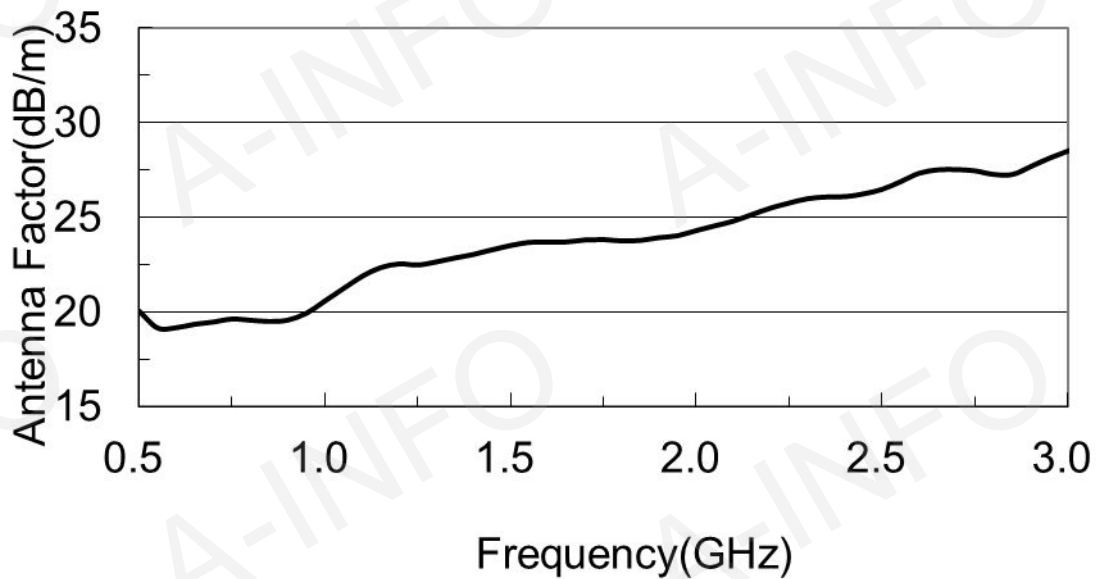

## 2. VSWR



### 3. Cross Polarization Isolation

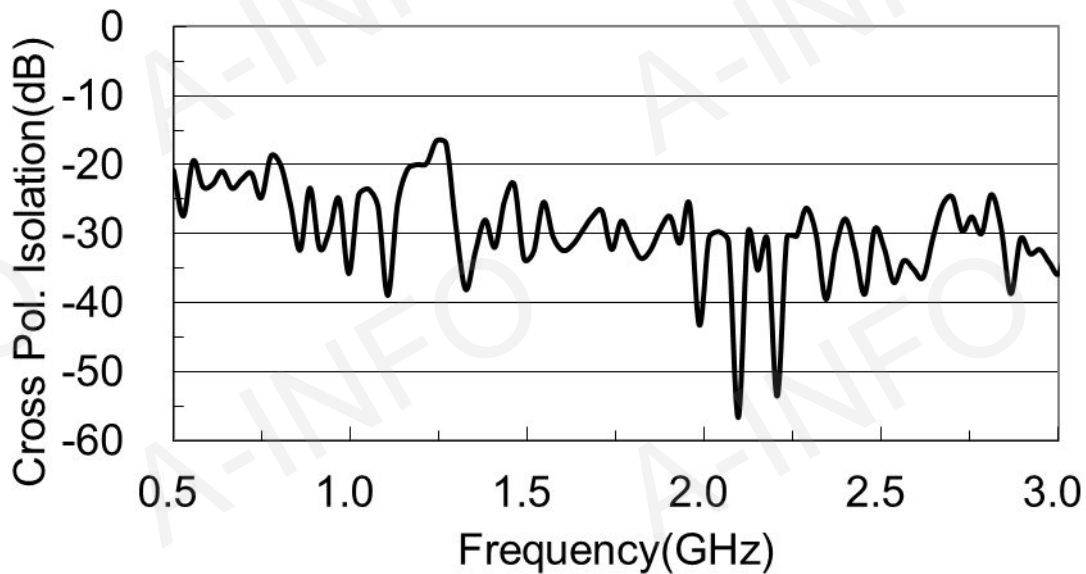

### 4. Pattern

