

Technical Specification



The picture is for reference only.

Frequency Range(GHz)	0.2 - 1.0
Gain(dB)	6 Typ.
Polarization	Linear
VSWR	1.5 Typ.
Connector	N-Female
Size(mm)	856 x 745
Net Weight(Kg)	1.0 Around

Outline Drawing (Size: mm)

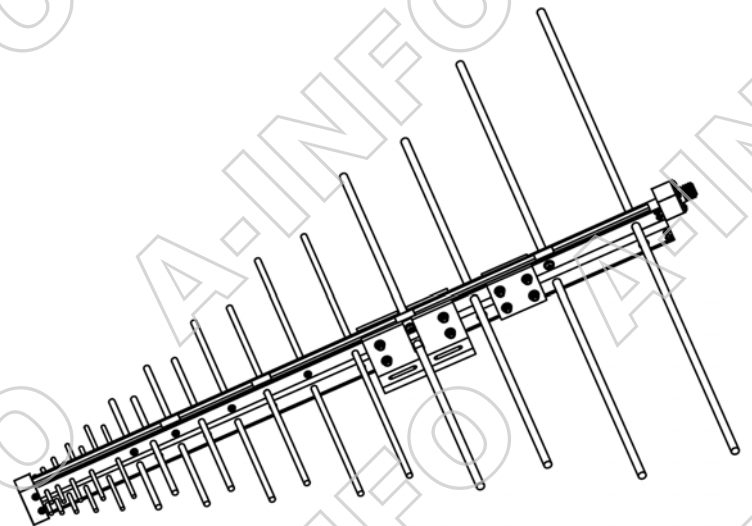
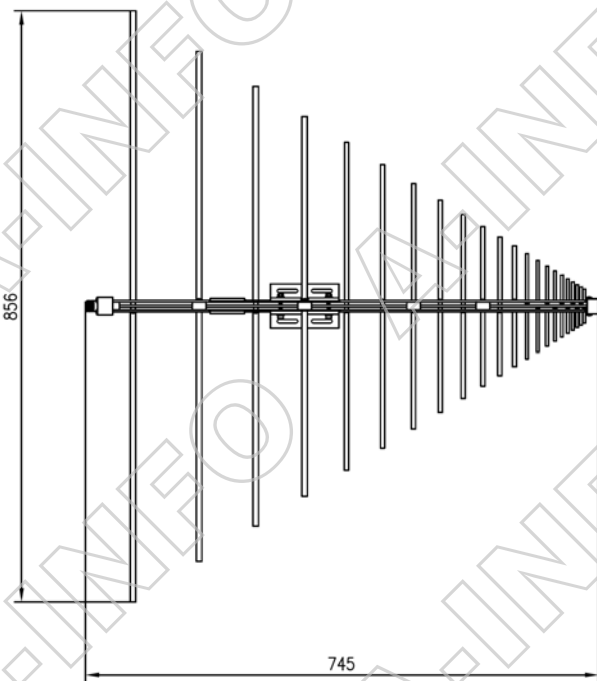

Mounting Bracket

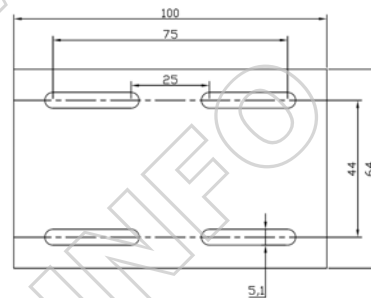

Test Results

1. Gain

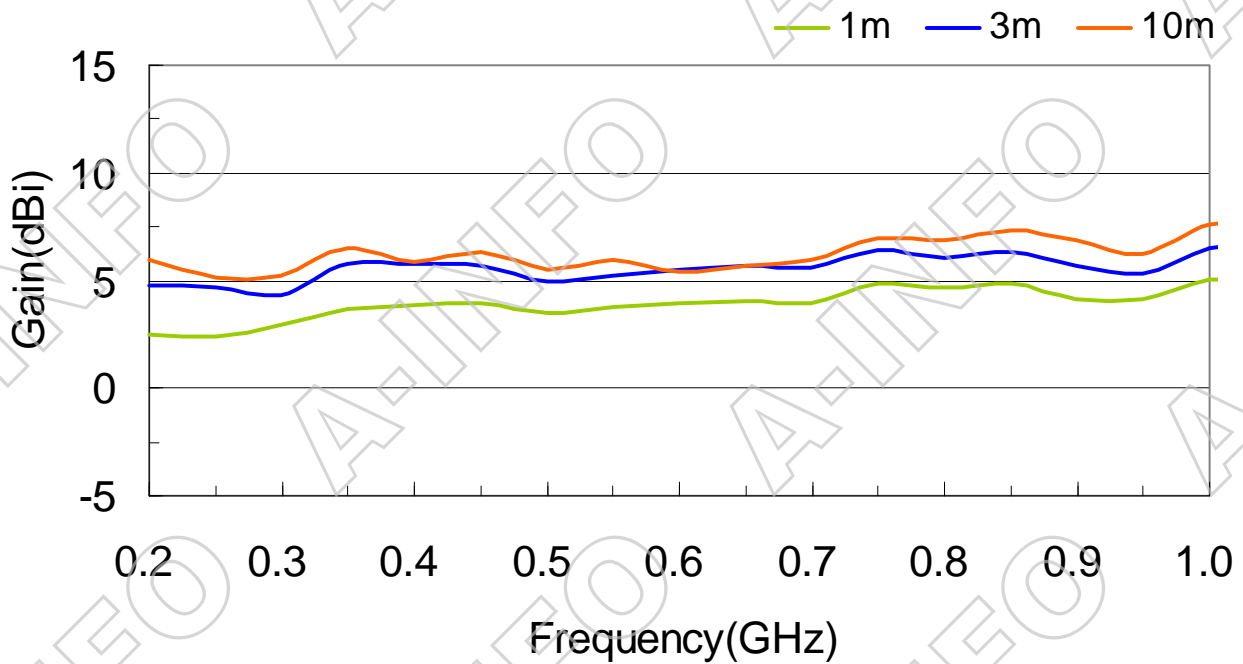

2. Antenna Factor

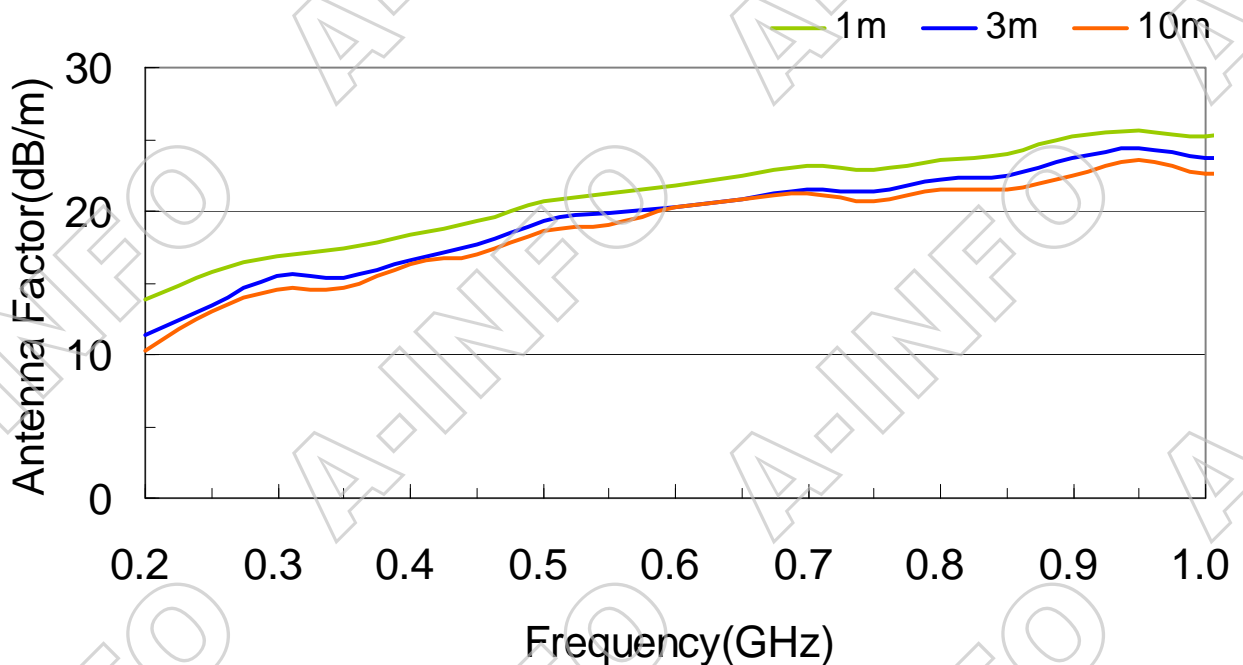

3. VSWR

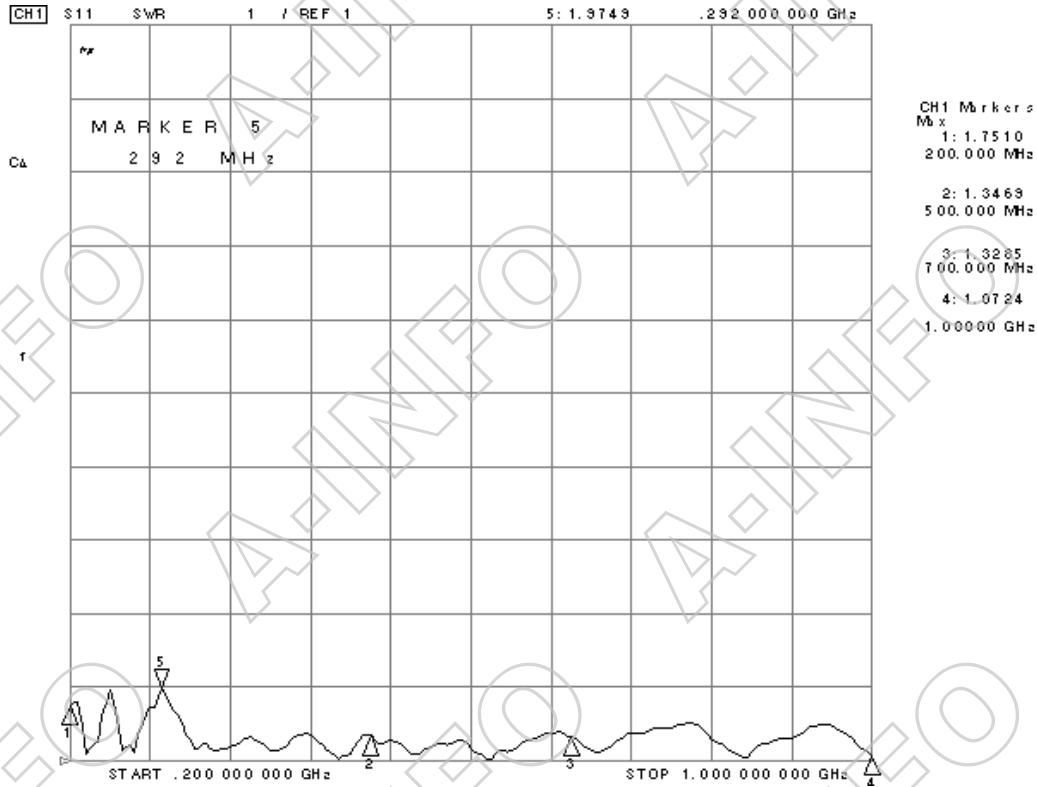

4. Pattern

