

Technical Specification



Frequency Range(GHz)	0.3 - 3.0
Gain(dB)	6 Typ.
Polarization	Linear
VSWR	2.0:1 Typ., 3.0:1 Max.
Connector	N-Female
Size(mm)	745.5 x 738.8
Net Weight(Kg)	0.9 Around

Outline Drawing (Size: mm)

N-Female Type Output

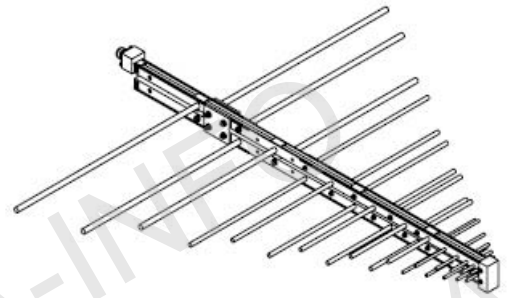
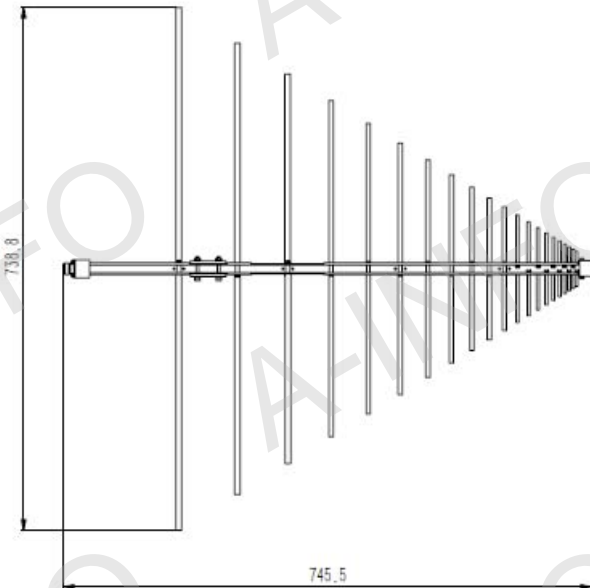

N-Female Type Output with Mounting Bracket

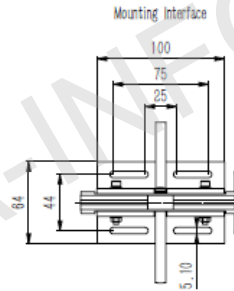
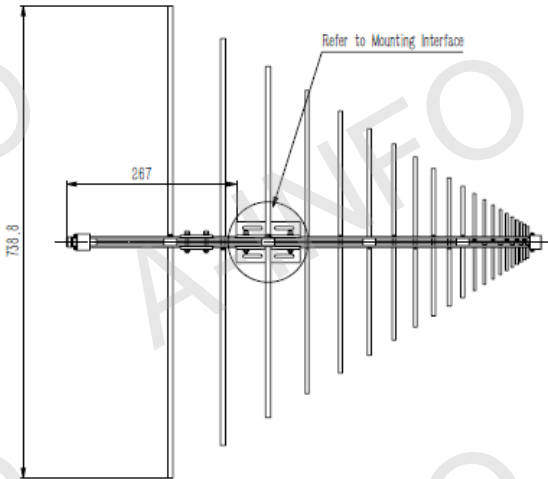
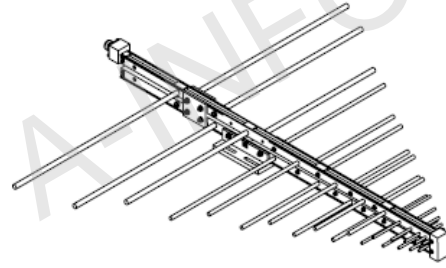
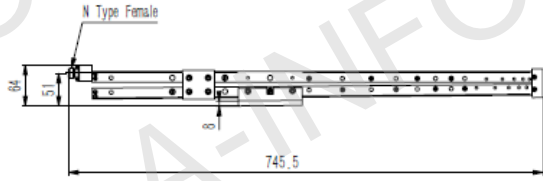

N-Female Type Output with Mounting Bracket for Tripod Application

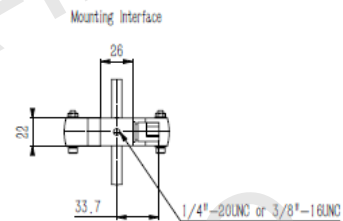
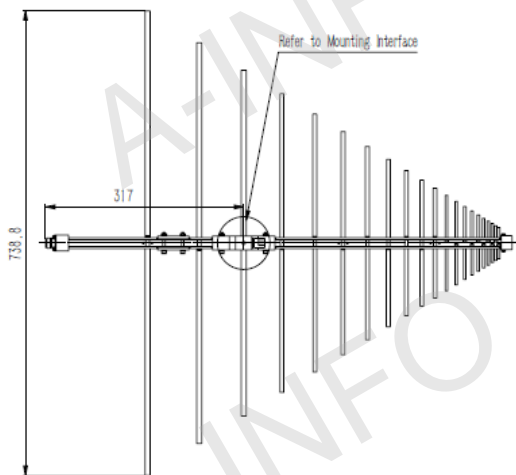
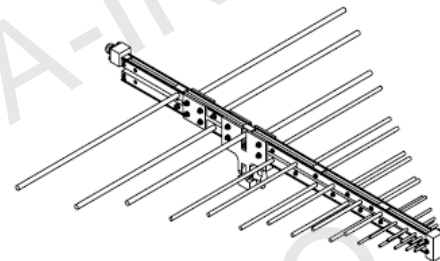
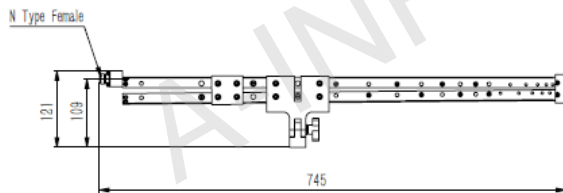

Test Results

1. Gain

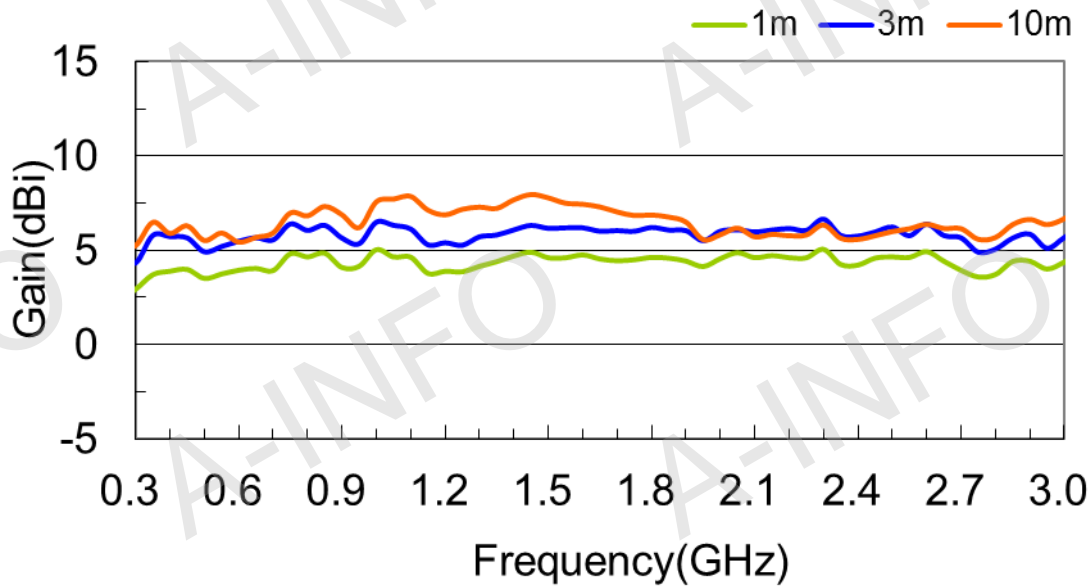

2. Antenna Factor

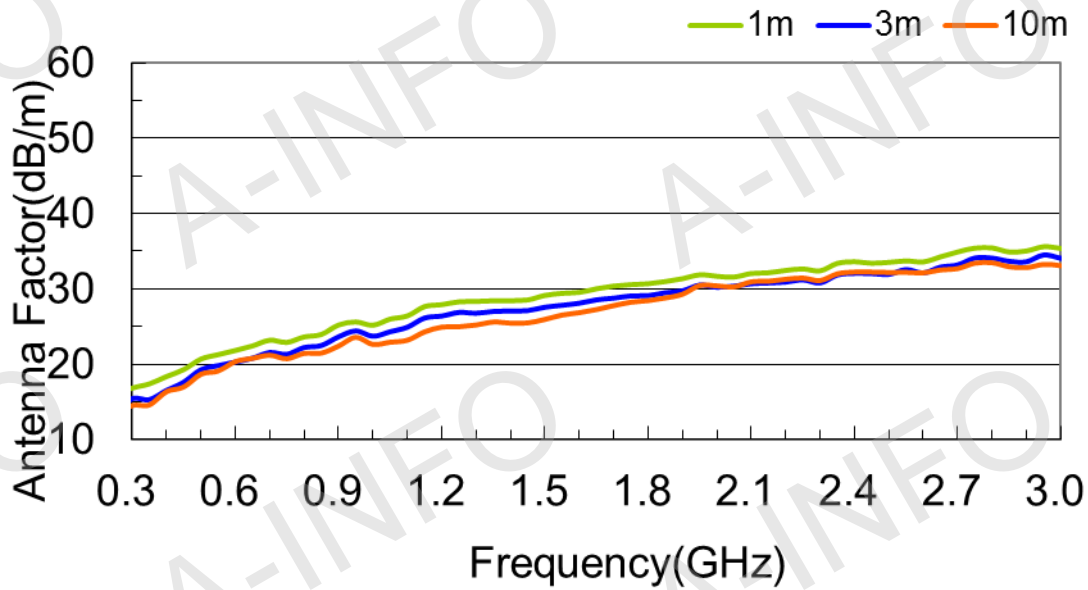

3. VSWR

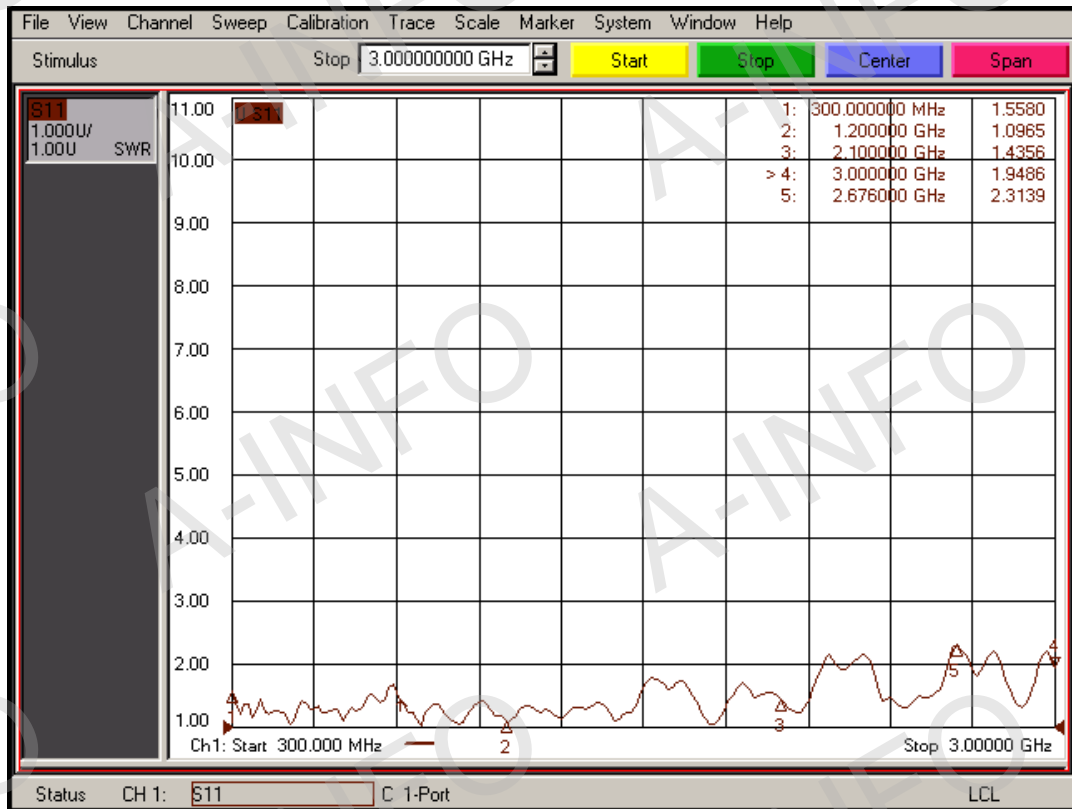

4. Pattern

