

---

# Eight Character 5.0 mm (0.2 inch) Glass/Ceramic Intelligent 5 x 7 Alphanumeric Displays for Military Applications

## Technical Data

**HDSP-2131**  
**HDSP-2132**  
**HDSP-2133**  
**HDSP-2179**

---

### Features

- **Wide Operating Temperature Range** -55°C to +85°C
- **Smart Alphanumeric Display**
  - On-Board CMOS IC
  - Built-In RAM
  - ASCII Decoder
  - LED Drive Circuitry
- **128 ASCII Character Set**
- **16 User Definable Characters**
- **Programmable Features**
  - Individual Character Flashing
  - Full Display Blinking
  - Multi-Level Dimming and Blanking
  - Self Test
  - Clear Function
- **Read/Write Capability**
- **Full TTL Compatibility**
- **HDSP-2131/-2133/-2179 Useable in Night Vision Lighting Applications**
- **Categorized for Luminous**

### Intensity

- **HDSP-2131/2133 Categorized for Color**
- **Excellent ESD Protection**
- **Wave Solderable**
- **X-Y Stackable**

### Description

The HDSP-2131 (yellow), HDSP-2179 (orange), HDSP-2132 (high efficiency red) and the HDSP-2133 (green) are eight-digit, 5 x 7 dot matrix, alphanumeric displays. The 5.0 mm (0.2 inch) high characters are packaged in a standard 7.64 mm (0.30 inch) 32 pin DIP. The on-board CMOS IC has the ability to decode 128 ASCII characters, which are permanently stored in ROM. In addition, 16 programmable symbols may be stored in an on-board RAM. Seven brightness levels provide versatility in

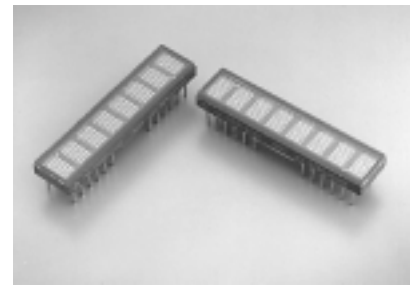

adjusting the display intensity and power consumption. The HDSP-213X is designed for standard microprocessor interface techniques. The display and special features are accessed through a bidirectional eight-bit data bus. These features make the HDSP-213X ideally suited for applications where a hermetic, low power alphanumeric display is required.

### Devices

Yellow	High Efficiency Red	High Performance Green	Orange
HDSP-2131	HDSP-2132	HDSP-2133	HDSP-2179

## Package Dimensions

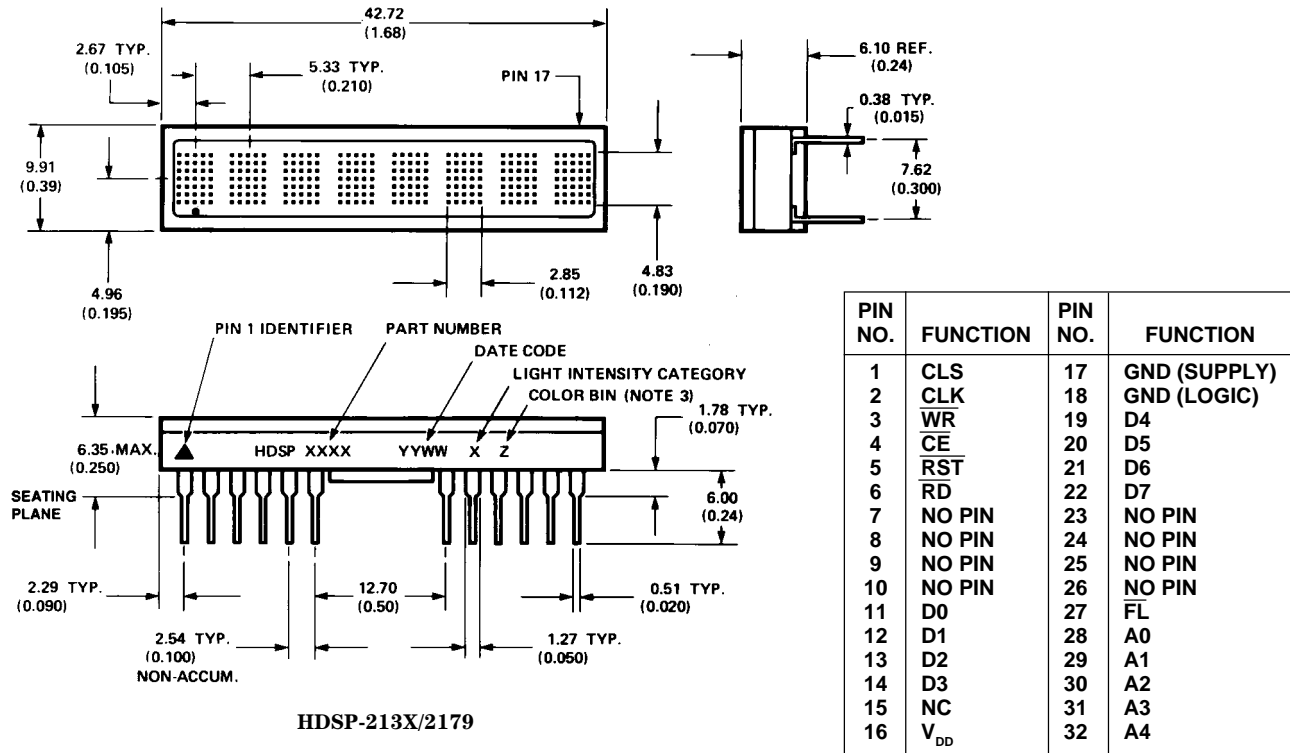

### Note:

1. All dimensions are in mm (inches).
2. Unless otherwise specified tolerance is  $\pm 0.30$  mm ( $\pm 0.015$ ).
3. For green and yellow devices only.
4. Leads are copper alloy, solder dipped.

### Absolute Maximum Ratings

Supply Voltage, V <sub>DD</sub> to Ground <sup>[1]</sup> .....	-0.3 to 7.0 V
Operating Voltage, V <sub>DD</sub> to Ground <sup>[2]</sup> .....	5.5 V
Input Voltage, Any Pin to Ground .....	-0.3 to V <sub>DD</sub> + 0.3 V
Free Air Operating Temperature Range, T <sub>A</sub> .....	-55°C to +85°C
Storage Temperature, T <sub>S</sub> .....	-55°C to +100°C
CMOS IC Junction Temperature, T <sub>J</sub> (IC) .....	+150°C
Wave Solder Temperature, 1.59 mm (0.063 in.) below Body .....	250°C for 3 secs
ESD Protection @ 1.5 kΩ, 100 pF .....	V <sub>Z</sub> = 4 kV (each pin)

### Notes:

1. Maximum voltage is with no LEDs illuminated.
2. 20 dots ON in all locations at full brightness.

**ESD WARNING: STANDARD CMOS HANDLING PRECAUTIONS SHOULD BE OBSERVED WITH THE HDSP-2131, HDSP-2132, HDSP-2133, AND HDSP-2179.**

# Character Set

BITS		D7	D6	D5	D4	D3	D2	D1	D0	COLUMN	ROW							
		→	→	→	→	↓	↓	↓	↓	→	↓							
		0	0	0	0	0	0	0	0	0	0	0	1					
		0	0	0	1	0	1	0	1	1	1	1	X					
		0	0	1	0	1	0	1	0	1	0	1	X					
		0	1	2	3	4	5	6	7	8-F								
0000	0																	16 USER DEFINED CHARACTERS
0001	1																	
0010	2																	
0011	3																	
0100	4																	
0101	5																	
0110	6																	
0111	7																	
1000	8																	
1001	9																	
1010	A																	
1011	B																	
1100	C																	
1101	D																	
1110	E																	
1111	F																	

## Recommended Operating Conditions

Parameter	Symbol	Minimum	Nominal	Maximum	Units
Supply Voltage	$V_{DD}$	4.5	5.0	5.5	V

## Electrical Characteristics over Operating Temperature Range

$4.5 < V_{DD} < 5.5$  V (unless otherwise specified)

Parameter	Symbol	Min.	25°C Typ. <sup>[1]</sup>	25°C Max. <sup>[1]</sup>	Max. <sup>[2]</sup>	Units	Test Conditions
Input Leakage (Input without pullup)	$I_I$	-10.0			+10.0	$\mu$ A	$V_{IN} = 0$ to $V_{DD}$ , pins CLK, D <sub>0</sub> -D <sub>7</sub> , A <sub>0</sub> -A <sub>4</sub>
Input Current (Input with pullup)	$I_{IP}$	-30.0	11	18	30	$\mu$ A	$V_{IN} = 0$ to $V_{DD}$ , pins $\overline{RST}$ , $\overline{CLS}$ , $\overline{WR}$ , $\overline{RD}$ , $\overline{CE}$ , $\overline{FL}$
$I_{DD}$ Blank	$I_{DD}(\text{BLK})$		0.5	1.5	2.0	mA	$V_{IN} = V_{DD}$
$I_{DD}$ 8 digits 12 dots/character <sup>[3]</sup>	$I_{DD}(V)$		200	255	330	mA	"V" on in all 8 locations
$I_{DD}$ 8 digits 20 dots/character <sup>[3]</sup>	$I_{DD}(\#)$		300	370	430	mA	"#" on in all 8 locations
Input Voltage High	$V_{IH}$	2.0			$V_{DD}$ +0.3	V	$V_{DD} = 5.5$ V
Input Voltage Low	$V_{IL}$	GND -0.3 V			0.8	V	$V_{DD} = 4.5$ V
Output Voltage High	$V_{OH}$	2.4				V	$V_{DD} = 4.5$ V, $I_{OH} = -40$ $\mu$ A
Output Voltage Low D <sub>0</sub> -D <sub>7</sub>	$V_{OL}$				0.4	V	$V_{DD} = 4.5$ V, $I_{OL} = 1.6$ mA
Output Voltage Low CLK					0.4	V	$V_{DD} = 4.5$ V, $I_{OL} = 40$ $\mu$ A
Thermal Resistance IC Junction-to-PIN	$R\theta_{J-PIN}$		11			°C/W	

### Notes:

- $V_{DD} = 5.0$  V.
- Maximum  $I_{DD}$  occurs at -55°C.
- Average  $I_{DD}$  measured at full brightness. See Table 2 in Control Word Section for  $I_{DD}$  at lower brightness levels. Peak  $I_{DD} = 28/15 \times$  Average  $I_{DD}(\#)$ .

### Optical Characteristics at 25°C<sup>[4]</sup>

V<sub>DD</sub> = 5.0 V at Full Brightness

#### High Efficiency Red HDSP-2132

Description	Symbol	Minimum	Typical	Units
Luminous Intensity Character Average (#)	I <sub>V</sub>	2.5	7.5	mcd
Peak Wavelength	λ <sub>PEAK</sub>		635	nm
Dominant Wavelength	λ <sub>d</sub>		626	nm

#### Orange HDSP-2179

Description	Symbol	Minimum	Typical	Units
Luminous Intensity Character Average (#)	I <sub>V</sub>	2.5	7.5	mcd
Peak Wavelength	λ <sub>PEAK</sub>		600	nm
Dominant Wavelength	λ <sub>d</sub>		602	nm

#### Yellow HDSP-2131

Description	Symbol	Minimum	Typical	Units
Luminous Intensity Character Average (#)	I <sub>V</sub>	2.5	7.5	mcd
Peak Wavelength	λ <sub>PEAK</sub>		583	nm
Dominant Wavelength	λ <sub>d</sub>		585	nm

#### High Performance Green HDSP-2133

Description	Symbol	Minimum	Typical	Units
Luminous Intensity Character Average (#)	I <sub>V</sub>	2.5	7.5	mcd
Peak Wavelength	λ <sub>PEAK</sub>		568	nm
Dominant Wavelength	λ <sub>d</sub>		574	nm

**Note:**

4. Refers to the initial case temperature of the device immediately prior to the light measurement.

## AC Timing Characteristics over Temperature Range

$V_{DD} = 4.5$  to  $5.5$  V unless otherwise specified.

Reference Number	Symbol	Description	Min. <sup>[1]</sup>	Units
1	$t_{ACC}$	Display Access Time Write Read	210 230	ns
2	$t_{ACS}$	Address Setup Time to Chip Enable	10	ns
3	$t_{CE}$	Chip Enable Active Time <sup>[2, 3]</sup> Write Read	140 160	ns
4	$t_{ACH}$	Address Hold Time to Chip Enable	20	ns
5	$t_{CER}$	Chip Enable Recovery Time	60	ns
6	$t_{CES}$	Chip Enable Active Prior to Rising Edge of <sup>[1,2]</sup> Write Read	140 160	ns
7	$t_{CEH}$	Chip Enable Hold Time to Rising Edge of Read/Write Signal <sup>[2, 3]</sup>	0	ns
8	$t_W$	Write Active Time <sup>[2,3]</sup>	100	ns
9	$t_{WD}$	Data Valid Prior to Rising Edge of Write Signal	50	ns
10	$t_{DH}$	Data Write Hold Time	20	ns
11	$t_R$	Chip Enable Active Prior to Valid Data	160	ns
12	$t_{RD}$	Read Active Prior to Valid Data	75	ns
13	$t_{DF}$	Read Data Float Delay	10	ns
	$t_{RC}$	Reset Active Time <sup>[4]</sup>	300	ns

### Notes:

1. Worst case values occur at an IC junction temperature of 150°C.
2. For designers who do not need to read from the display, the Read line can be tied to  $V_{DD}$  and the Write and Chip Enable lines can be tied together.
3. Changing the logic levels of the Address lines when  $\overline{CE} = "0"$  may cause erroneous data to be entered into the Character RAM, regardless of the logic levels of the  $\overline{WR}$  and  $\overline{RD}$  lines.
4. The display must not be accessed until after 3 clock pulses (110  $\mu$ s min. using the internal refresh clock) after the rising edge of the reset line.

## AC Timing Characteristics over Temperature Range

$V_{DD} = 4.5$  to  $5.5$  V unless otherwise specified.

Symbol	Description	25°C Typical	Minimum <sup>[1]</sup>	Units
$F_{OSC}$	Oscillator Frequency	57	28	kHz
$F_{RF}^{[5]}$	Display Refresh Rate	256	128	Hz
$F_{FL}^{[6]}$	Character Flash Rate	2	1	Hz
$t_{ST}^{[7]}$	Self Test Cycle Time	4.6	9.2	Sec

### Notes:

5.  $F_{RF} = F_{OSC}/224$ .

6.  $F_{FL} = F_{OSC}/28,672$ .

7.  $t_{ST} = 262,144/F_{OSC}$ .

## Write Cycle Timing Diagram

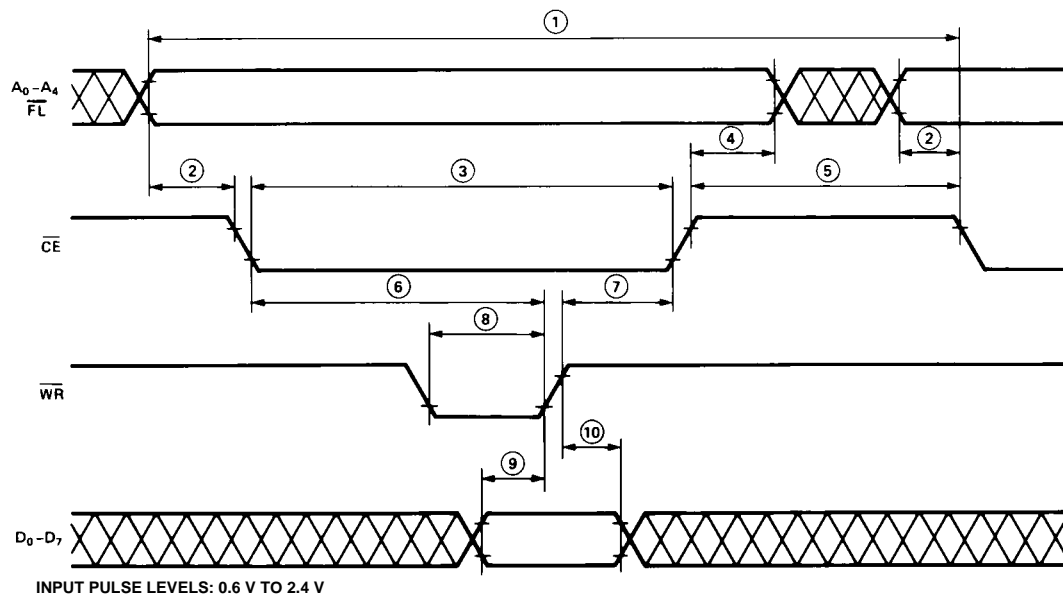

### Read Cycle Timing Diagram

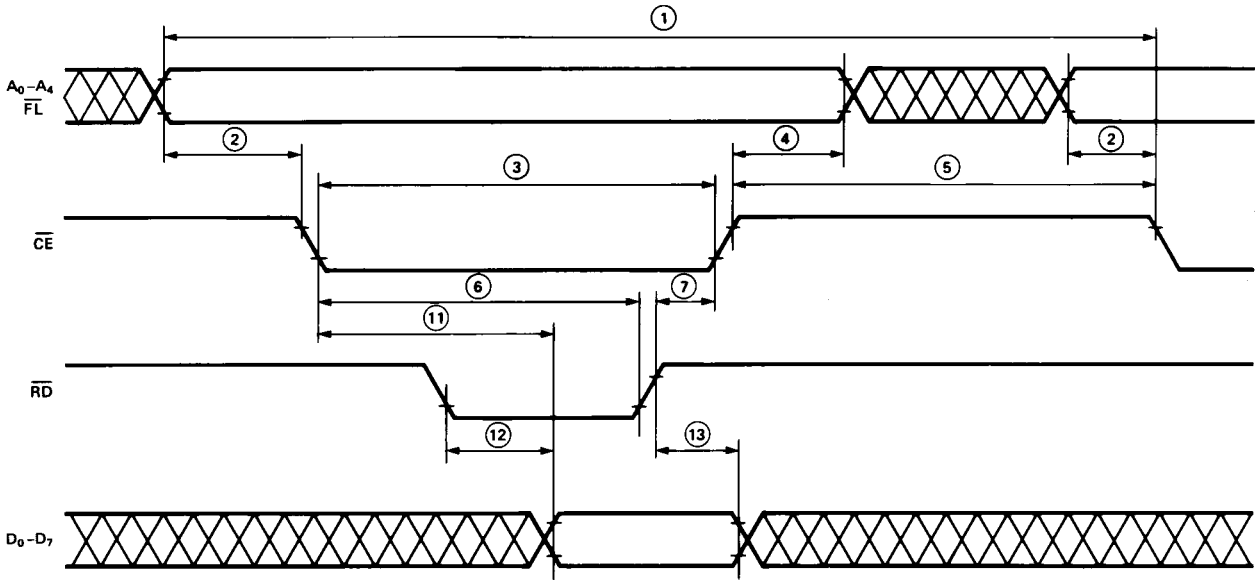

INPUT PULSE LEVELS: 0.6 V TO 2.4 V  
 OUTPUT REFERENCE LEVELS: 0.6 V TO 2.2 V  
 OUTPUT LOADING = 1 TTL LOAD AND 100pF

### Character Font

(Not to Scale)

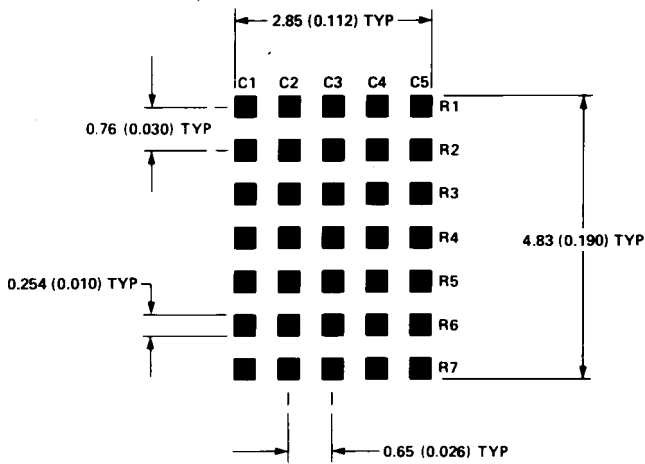

### Relative Luminous Intensity vs. Temperature

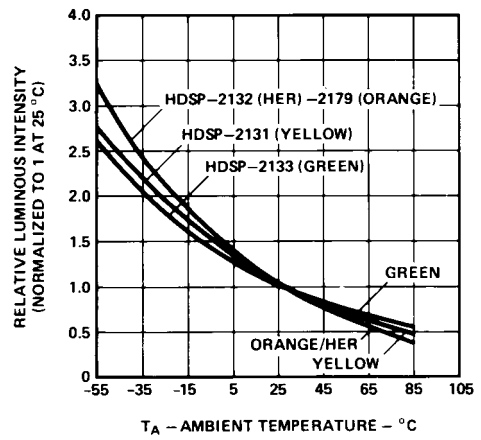



## Electrical Description

### Pin Function

RESET ( $\overline{\text{RST}}$ , pin 5)

Reset initializes the display.

FLASH ( $\overline{\text{FL}}$ , pin 27)

$\overline{\text{FL}}$  low indicates an access to the Flash RAM and is unaffected by the state of address lines  $A_3$ - $A_4$ .

ADDRESS INPUTS  
( $A_0$ - $A_4$ , pins 28-32)

Each location in memory has a distinct address. Address inputs ( $A_0$ - $A_2$ ) select a specific location in the Character RAM, the Flash RAM or a particular row in the UDC (User-Defined Character) RAM.  $A_3$ - $A_4$  are used to select which section of memory is accessed. Table 1 shows the logic levels needed to access each section of memory.

**Table 1. Logic Levels to Access Memory**

$\overline{\text{FL}}$	$A_4$	$A_3$	Section of Memory	$A_2$ $A_1$ $A_0$
0	X	X	Flash RAM	Character Address
1	0	0	UDC Address Register	Don't Care
1	0	1	UDC RAM	Row Address
1	1	0	Control Word Register	Don't Care
1	1	1	Character RAM	Character Address

CLOCK SELECT  
(CLS, pin 1)

This input is used to select either an internal (CLS = 1) or external (CLS = 0) clock source.

CLOCK INPUT/OUTPUT  
(CLK, pin 2)

Outputs the master clock (CLS = 1) or inputs a clock (CLS = 0) for slave displays.

WRITE ( $\overline{\text{WR}}$ , pin 3)

Data is written into the display when the  $\overline{\text{WR}}$  input is low and the  $\overline{\text{CE}}$  input is low.

CHIP ENABLE ( $\overline{\text{CE}}$ , pin 4)

This input must be at a logic low to read or write data to the display and must go high between each read and write cycle.

READ ( $\overline{\text{RD}}$ , pin 6)

Data is read from the display when the  $\overline{\text{RD}}$  input is low and the  $\overline{\text{CE}}$  input is low.

DATA Bus ( $D_0$ - $D_7$ ,  
pins 11-14, 19-22)

The Data bus is used to read from or write to the display.

$\text{GND}_{(\text{SUPPLY})}$  (pin 17)

This is the analog ground for the LED drivers.

$\text{GND}_{(\text{LOGIC})}$  (pin 18)

This is the digital ground for internal logic.

$V_{\text{DD}(\text{POWER})}$  (pin 16)

This is the positive power supply input.

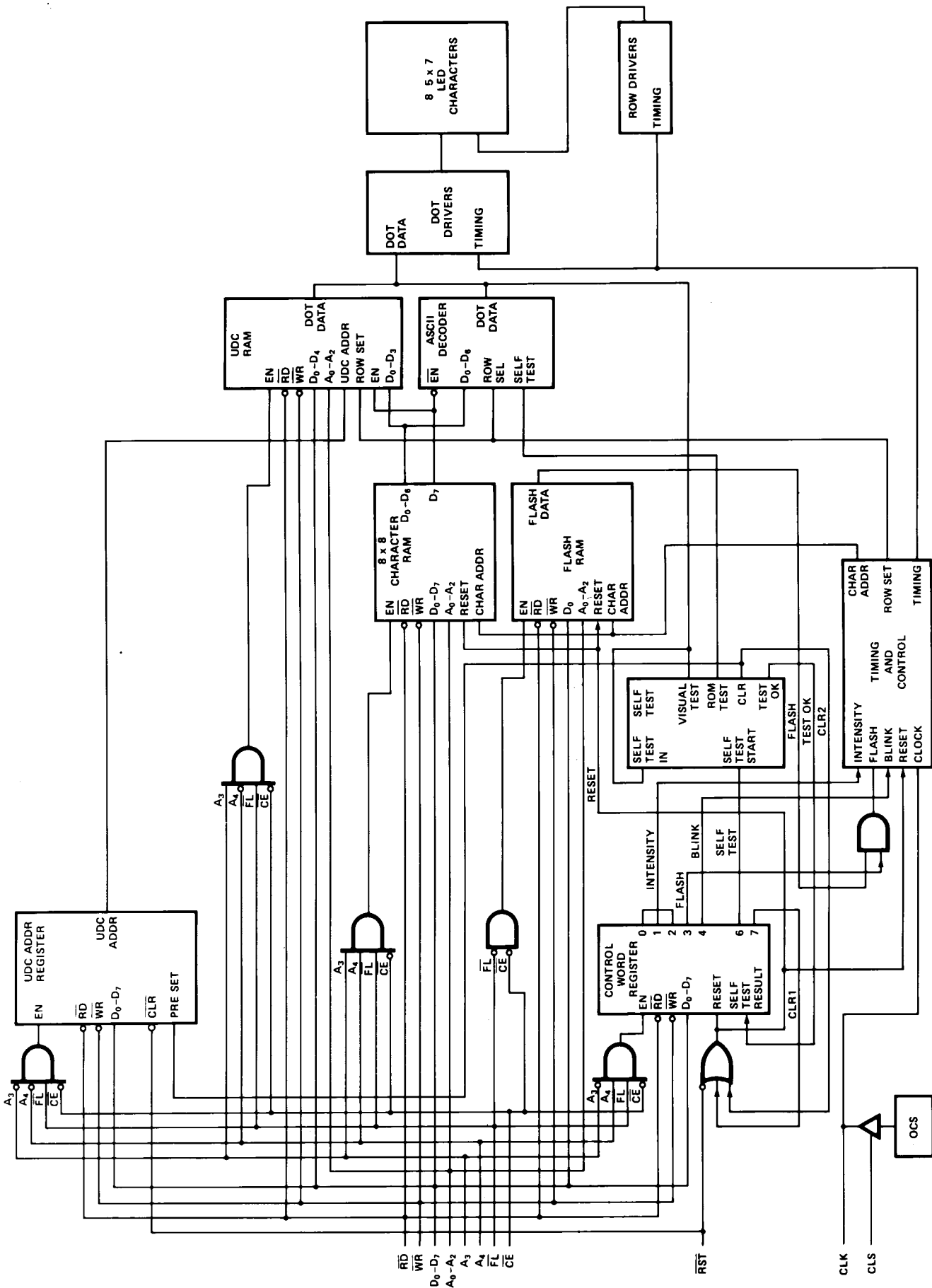

Figure 1. HDSP-213X/-2179 Internal Block Diagram.

**Display Internal Block Diagram**

Figure 1 shows the internal block diagram of the HDSP-213X/-2179 display. The CMOS IC consists of an 8 byte Character RAM, an 8 bit

Flash RAM, a 128 character ASCII decoder, a 16 character UDC RAM, a UDC Address Register, a Control Word Register, and the refresh circuitry necessary to synchronize the decoding and

driving of eight 5 x 7 dot matrix characters. The major user accessible portions of the display are listed below:

Character RAM	This RAM stores either ASCII character data or a UDC RAM address.
Flash RAM	This is a 1 x 8 RAM which stores Flash data.
User-Defined Character RAM (UDC RAM)	This RAM stores the dot pattern for custom characters.
User-defined Character Address Register (UDC Address Register)	This register is used to provide the address to the UDC RAM when the user is writing or reading a custom character.
Control Word Register	This register allows the user to adjust the display brightness, flash individual characters, blink, self test or clear the display.

**Character Ram**

Figure 2 shows the logic levels needed to access the HDSP-213X Character RAM. During a normal access the  $\overline{CE} = "0"$  and either  $\overline{RD} = "0"$  or  $\overline{WR} = "0"$ . However, erroneous data may be written into the Character RAM if the Address lines are unstable when  $\overline{CE} = "0"$  regardless of the logic levels of the  $\overline{RD}$  or  $\overline{WR}$  lines. Address lines  $A_0$ - $A_2$  are used to select the location in the Character RAM. Two types of data can be stored in each Character RAM location: an ASCII code or a UDC RAM address. Data bit  $D_7$  is used to differentiate between an ASCII character and a UDC RAM address.  $D_7 = 0$  enables the ASCII decoder and  $D_7 = 1$  enables the UDC RAM.  $D_0$ - $D_6$  are used to input ASCII data and  $D_0$ - $D_3$  are used to input a UDC address.

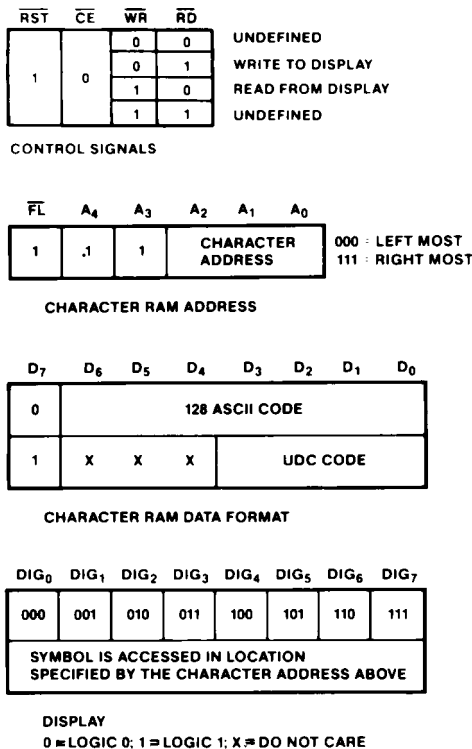

Figure 2. Logic Levels to Access the Character RAM.

**UDC RAM and UDC Address Register**

Figure 3 shows the logic levels needed to access the UDC RAM and the UDC Address Register. The UDC Address Register is eight bits wide. The lower four bits (D<sub>0</sub>-D<sub>3</sub>) are used to select one of the 16 UDC locations. The upper four bits (D<sub>4</sub>-D<sub>7</sub>) are not used. Once the UDC address has been stored in the UDC Address Register, the UDC RAM can be accessed.

To completely specify a 5 x 7 character requires eight write cycles. One cycle is used to store the UDC RAM address in the UDC Address Register. Seven cycles are used to store dot data in the UDC RAM. Data is entered by rows. One cycle is needed to access each row. Figure 4 shows the organization of a UDC character assuming the symbol to be stored is an "F." A<sub>0</sub>-A<sub>2</sub> are used to select the row to be accessed and D<sub>0</sub>-D<sub>4</sub> are used to transmit the row dot data. The upper three bits (D<sub>5</sub>-D<sub>7</sub>) are ignored. D<sub>0</sub> (least significant bit) corresponds to the right most column of the 5 x 7 matrix and D<sub>4</sub> (most significant bit) corresponds to the left most column of the 5 x 7 matrix.

**Flash RAM**

Figure 5 shows the logic levels needed to access the Flash RAM. The Flash RAM has one bit associated with each location of the Character RAM. The Flash input is used to select the Flash RAM. Address lines A<sub>3</sub>-A<sub>4</sub> are ignored. Address lines A<sub>0</sub>-A<sub>2</sub> are used to select the location in the Flash RAM to store the attribute. D<sub>0</sub> is used to store or remove the flash attribute. D<sub>0</sub> = "1" stores the attribute and D<sub>0</sub> = "0" removes the attribute.

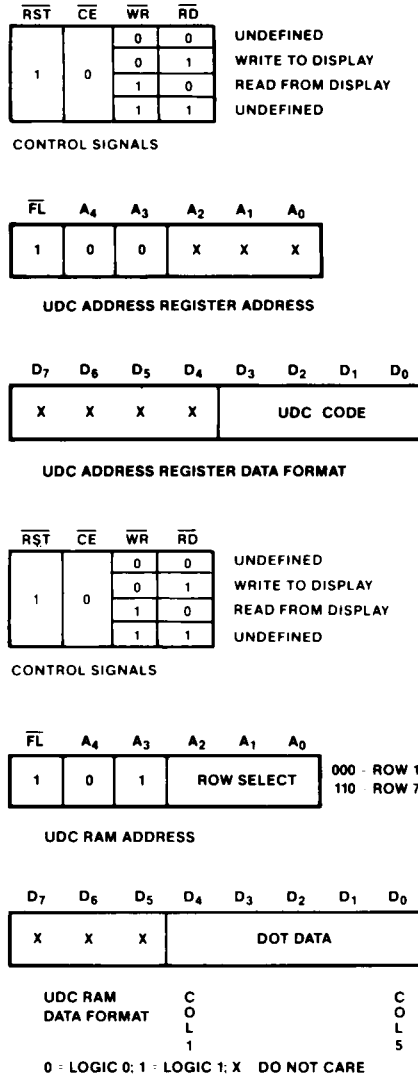

Figure 3. Logic Levels to Access a UDC Character.

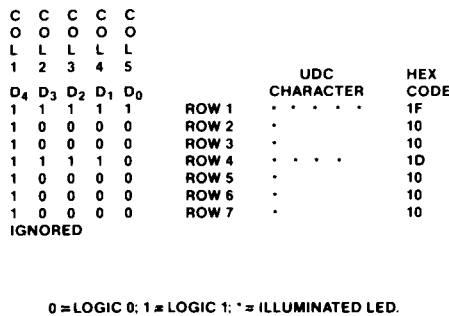

Figure 4. Data to Load "F" into the UDC RAM.

When the attribute is enabled through bit 3 of the Control Word and a "1" is stored in the Flash RAM, the corresponding character will flash at approximately 2 Hz.

The actual rate is dependent on the clock frequency. For an external clock the flash rate can be calculated by dividing the clock frequency by 28,672.

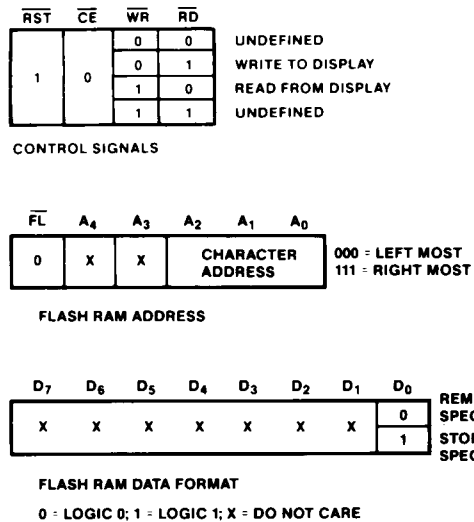

Figure 5. Logic Levels to Access the Flash RAM.

### Control Word Register

Figure 6 shows how to access the Control Word Register. This is an eight bit register which performs five functions. They are Brightness control, Flash RAM control, Blinking, Self Test and Clear. Each function is independent of the others. However, all bits are updated during each Control Word write cycle.

#### Brightness (Bits 0-2)

Bits 0-2 of the Control Word adjust the brightness of the display. Bits 0-2 are interpreted as a three bit binary code with code (000) corresponding to maximum brightness and code (111) corresponding to a blanked display. In addition to varying the display brightness, bits 0-2 also vary the average value of  $I_{DD}$ .  $I_{DD}$  can be calculated at any brightness level by multiplying the percent brightness level by the value of  $I_{DD}$  at the 100% brightness level. These values of  $I_{DD}$  are shown in Table 2.

#### Flash Function (Bit 3)

Bit 3 determines whether the flashing character attribute is on or off. When bit 3 is a "1," the output of the Flash RAM is checked. If the content of a location in the Flash RAM is a "1," the associated digit will flash at

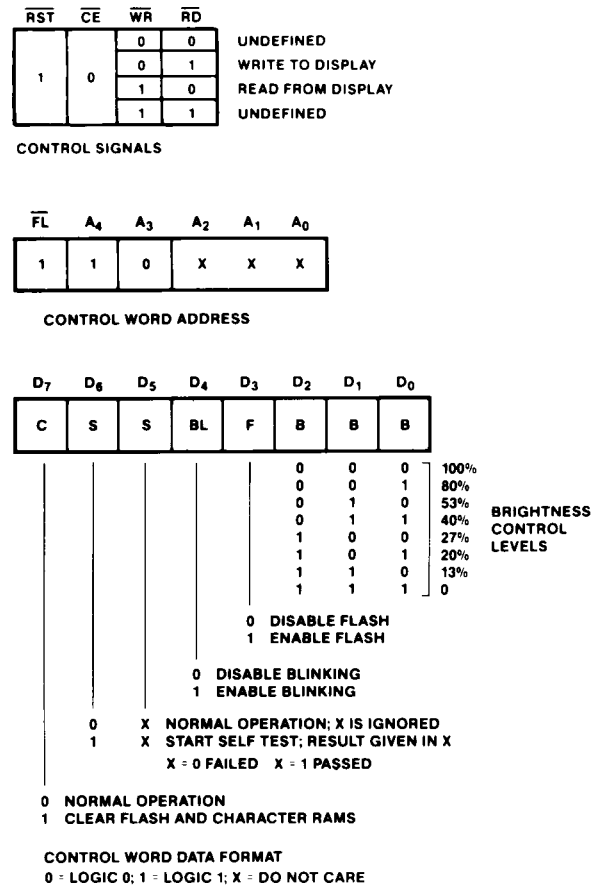

Figure 6. Logic Levels to Access the Control Word Register

Table 2. Current Requirements at Different Brightness Levels

Symbol	D <sub>2</sub>	D <sub>1</sub>	D <sub>0</sub>	% Brightness	25°C Typical	Units
I <sub>DD</sub> (V)	0	0	0	100	200	mA
	0	0	1	80	160	mA
	0	1	0	53	106	mA
	0	1	1	40	80	mA
	1	0	0	27	54	mA
	1	0	1	20	40	mA
	1	1	0	13	26	mA

approximately 2 Hz. For an external clock, the blink rate can be calculated by driving the clock frequency by 28,672. If the flash enable bit of the Control Word is a "0," the content of the Flash RAM is ignored. To use this function with multiple display systems see the Reset section.

#### Blink Function (Bit 4)

Bit 4 of the Control Word is used to synchronize blinking of all

eight digits of the display. When this bit is a "1" all eight digits of the display will blink at approximately 2 Hz. The actual rate is dependent on the clock frequency. For an external clock, the blink rate can be calculated by dividing the clock frequency by 28,672. This function will override the Flash function when it is active. To use this function with multiple display systems see the Reset section.

### Self Test Function (Bits 5, 6)

Bit 6 of the Control Word Register is used to initiate the self test function. Results of the internal self test are stored in bit 5 of the Control Word. Bit 5 is a read only bit where bit 5 = "1" indicates a passed self test and bit 5 = "0" indicates a failed self test.

Setting bit 6 to a logic 1 will start the self test function. The built-in self test function of the IC consists of two internal routines which exercises major portions of the IC and illuminates all of the LEDs. The first routine cycles the ASCII decoder ROM through all states and performs a checksum on the output. If the checksum agrees with the correct value, bit 5 is set to "1." The second routine provides a visual test of the LEDs using the drive circuitry. This is accomplished by writing checkered and inverse checkered patterns to the display. Each pattern is displayed for approximately 2 seconds.

During the self test function the display must not be accessed. The time needed to execute the self test function is calculated by multiplying the clock period by 262,144. For example, assume a clock frequency of 58 KHz, then the time to execute the self test function frequency is equal to  $(262,144/58,000) = 4.5$  second duration.

At the end of the self test function, the Character RAM is loaded with blanks, the Control Word Register is set to zeros except for bit 5, and the Flash RAM is cleared and the UDC Address Register is set to all ones.

### Clear Function (Bit 7)

Bit 7 of the Control Word will clear the Character RAM and the Flash RAM. Setting bit 7 to a "1" will start the clear function. Three clock cycles (110  $\mu$ s min. using the internal refresh clock) are required to complete the clear function. The display must not be accessed while the display is being cleared. When the clear function has been completed, bit 7 will be reset to a "0." The ASCII character code for a space (20H) will be loaded into the Character RAM to blank the display and the Flash RAM will be loaded with "0"s. The UDC RAM, UDC Address Register, and the remainder of the Control Word are unaffected.

### Display Reset

Figure 7 shows the logic levels needed to Reset the display. The display should be Reset on Power-up. The external Reset clears the Character RAM, Flash RAM, Control Word and resets the internal counters. After the rising edge of the Reset signal, three clock cycles (110  $\mu$ s min. using the internal refresh clock) are required to complete the reset sequence. The display must not be accessed while the display is being reset. The ASCII Character code for a space (20H) will be loaded into the Character RAM to blank the display. The Flash RAM and Control Word Register are loaded with all "0"s. The UDC RAM and UDC Address Register

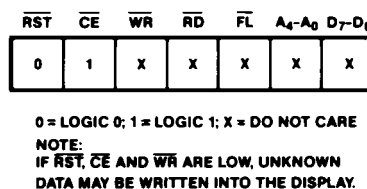

Figure 7. Logic Levels to Reset the Display.

are unaffected. All displays which operate with the same clock source must be simultaneously reset to synchronize the Flashing and Blinking functions.

### Mechanical and Electrical Considerations

The HDSP-213X/-2179 is a 32 pin dual-in-line package with 24 external pins, which can be stacked horizontally and vertically to create arrays of any size. The HDSP-213X/-2179 is designed to operate continuously from -55°C to +85°C with a maximum of 20 dots ON per character. Illuminating all thirty-five dots at full brightness is not recommended.

The HDSP-213X/-2179 is assembled by die attaching and wire bonding 280 LED chips and a CMOS IC to a ceramic substrate. A glass window is placed over the ceramic substrate creating an air gap over the LED wire bonds. A second glass window creates an air gap over the CMOS IC. This package construction makes the display highly tolerant to temperature cycling and allows wave soldering and visual inspection of the IC.

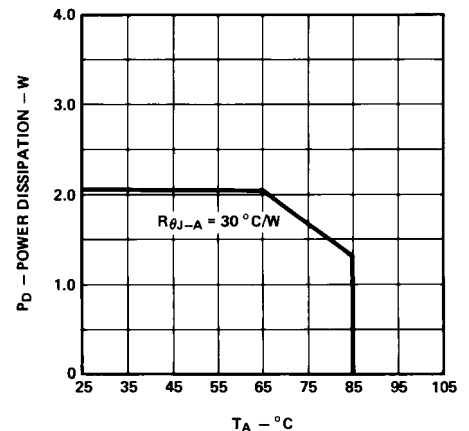

Figure 8. Maximum Power Dissipation vs. Ambient Temperature Derating Based on  $T_{j\text{MAX}} = 125^\circ\text{C}$ .

The inputs to the CMOS IC are protected against static discharge and input current latchup. However, for best results standard CMOS handling precautions should be used. Prior to use, the HDSP-213X should be stored in antistatic packages or conductive material. During assembly, a grounded conductive work area should be used, and assembly personnel should wear conductive wrist straps. Lab coats made of synthetic material should be avoided since they are prone to static charge buildup. Input current latchup is caused when the CMOS inputs are subjected to either a voltage below ground ( $V_{IN} < \text{ground}$ ) or to a voltage higher than  $V_{DD}$  ( $V_{IN} > V_{DD}$ ) and when a high current is forced into the input. To prevent input current latchup and ESD damage, unused inputs should be connected either to ground or to  $V_{DD}$ . Voltages should not be applied to the inputs until  $V_{DD}$  has been applied to the display. Transient input voltages should be eliminated.

### Thermal Considerations

The HDSP-213X/-2179 has been designed to provide a low thermal resistance path from the CMOS IC to the 24 package pins. This heat is then typically conducted through the traces of the user's printed circuit board to free air. For most applications no additional heatsinking is required.

The maximum operating IC junction temperature is 150°C. The maximum IC junction temperature can be calculated using the following equation:

$$T_{J(IC) \text{ MAX}} = T_A + (P_{D \text{ MAX}}) (R\theta_{J-PIN} + R\theta_{PIN-A})$$

Where

$$P_{D \text{ MAX}} = (V_{DD \text{ MAX}}) (I_{DD \text{ MAX}})$$

$I_{DD \text{ MAX}} = 370 \text{ mA}$  with 20 dots ON in eight character locations at 25°C ambient. This value is from the Electrical Characteristics table.

$$P_{D \text{ MAX}} = (5.5 \text{ V}) (0.370 \text{ A}) = 2.04 \text{ W}$$

### Ground Connections

Two ground pins are provided to keep the internal IC logic ground clean. The designer can, when necessary, route the analog ground for the LED drivers separately from the logic ground until an appropriate ground plane is available. On long interconnects between the display and the host system, the designer can keep voltage drops on the analog ground from affecting the display logic levels by isolating the two grounds.

The logic ground should be connected to the same ground potential as the logic interface circuitry. The analog ground and the logic ground should be connected at a common ground which can withstand the current introduced by the switching LED drivers. When separate ground connections are used, the analog ground can vary from -0.3 V to +0.3 V with respect to the logic ground. Voltage below -0.3 V can cause all dots to be on. Voltage above +0.3 V can cause dimming and dot mismatch.

### ESD Susceptibility

These displays have ESD susceptibility ratings of CLASS 3 per DOD-STD-1686 and CLASS B per MIL-STD-883C.

### Soldering and Post Solder Cleaning Instructions for the HDSP-213X/-2179

The HDSP-213X/-2179 may be hand soldered or wave soldered with SN63 solder. When hand soldering it is recommended that an electronically temperature controlled and securely grounded soldering iron be used. For best results, the iron tip temperature should be set at 315°C (600°F). For wave soldering, a rosin-based RMA flux can be used. The solder wave temperature should be set at  $245^\circ\text{C} \pm 5^\circ\text{C}$  ( $473^\circ\text{F} \pm 9^\circ\text{F}$ ), and dwell in the wave should be set between 1<sup>1/2</sup> to 3 seconds for optimum soldering. The preheat temperature should not exceed 105°C (221°F) as measured on the solder side of the PC board.

For further information on soldering and post solder cleaning, see Application Note 1027, *Soldering LED Components*.

### Contrast Enhancement

When used with the proper contrast enhancement filters, the HCMS-213X/-2179 series displays are readable daylight ambients. Refer to Application Note 1029 *Luminous Contrast and Sunlight Readability of the HDSP-235X Series Alphanumeric Displays for Military Applications* for information on contrast enhancement for daylight

ambients. Refer to Application Note 1015 *Contrast Enhancement Techniques for LED Displays* for information on contrast enhancement in moderate ambients.

### Night Vision Lighting

When used with the proper NVG/DV filters, the HDSP-2131, HDSP-2179 and HDSP-2133 may be used in night

vision lighting applications. The HDSP-2131 (yellow), HDSP-2179 (orange) displays are used as master caution and warning indicators. The HDSP-2133 (high performance green) displays are used for general instrumentation. For a list of NVG/DV filters and a discussion on night vision lighting technology, refer to Application Note 1030 *LED Displays and Indicators and Night Vision*

*Imaging System Lighting*. An external dimming circuit must be used to dim these displays to night vision lighting levels to meet NVIS radiance requirements. Refer to AN 1039 *Dimming HDSP-213X Displays to Meet Night Vision Lighting Levels*.

### Intensity Bin Limits

Bin	Intensity Range (mcd)	
	Min.	Max.
G	2.50	4.00
H	3.41	6.01
I	5.12	9.01
J	7.68	13.52
K	11.52	20.28

**Note:**

Test conditions as specified in Optical Characteristic table.

### Color Bin Limits

Color	Bin	Color Range (nm)	
		Min.	Max.
Green	1	576.0	580.0
	2	573.0	577.0
	3	570.0	574.0
	4	567.0	571.5
Yellow	3	581.5	585.0
	4	584.0	587.5
	5	586.5	590.0
	6	589.0	592.5

**Note:**

Test conditions as specified in Optical Characteristic table.

### [www.agilent.com/semiconductors](http://www.agilent.com/semiconductors)

For product information and a complete list of distributors, please go to our web site.

For technical assistance call:

Americas/Canada: +1 (800) 235-0312 or (916) 788-6763

Europe: +49 (0) 6441 92460

China: 10800 650 0017

Hong Kong: (+65) 6756 2394

India, Australia, New Zealand: (+65) 6755 1939

Japan: (+81 3) 3335-8152 (Domestic/International), or 0120-61-1280 (Domestic Only)

Korea: (+65) 6755 1989

Singapore, Malaysia, Vietnam, Thailand, Philippines, Indonesia: (+65) 6755 2044

Taiwan: (+65) 6755 1843

Data subject to change.

Copyright © 2004 Agilent Technologies, Inc.

Obsoletes 5988-2258EN

July 19, 2004

5988-4667EN