

Technical Specification



Frequency Range(GHz)	1.0 - 18.0
Gain(dB)	0 Typ.
Polarization	Linear
VSWR	2.0:1 Typ.
Power(W)	80 CW
Connector	SMA-Female
Size(mm) Φ x H	110 x 71
Net Weight(Kg)	0.5 Around

Outline Drawing (Size: mm)

SMA Female Output

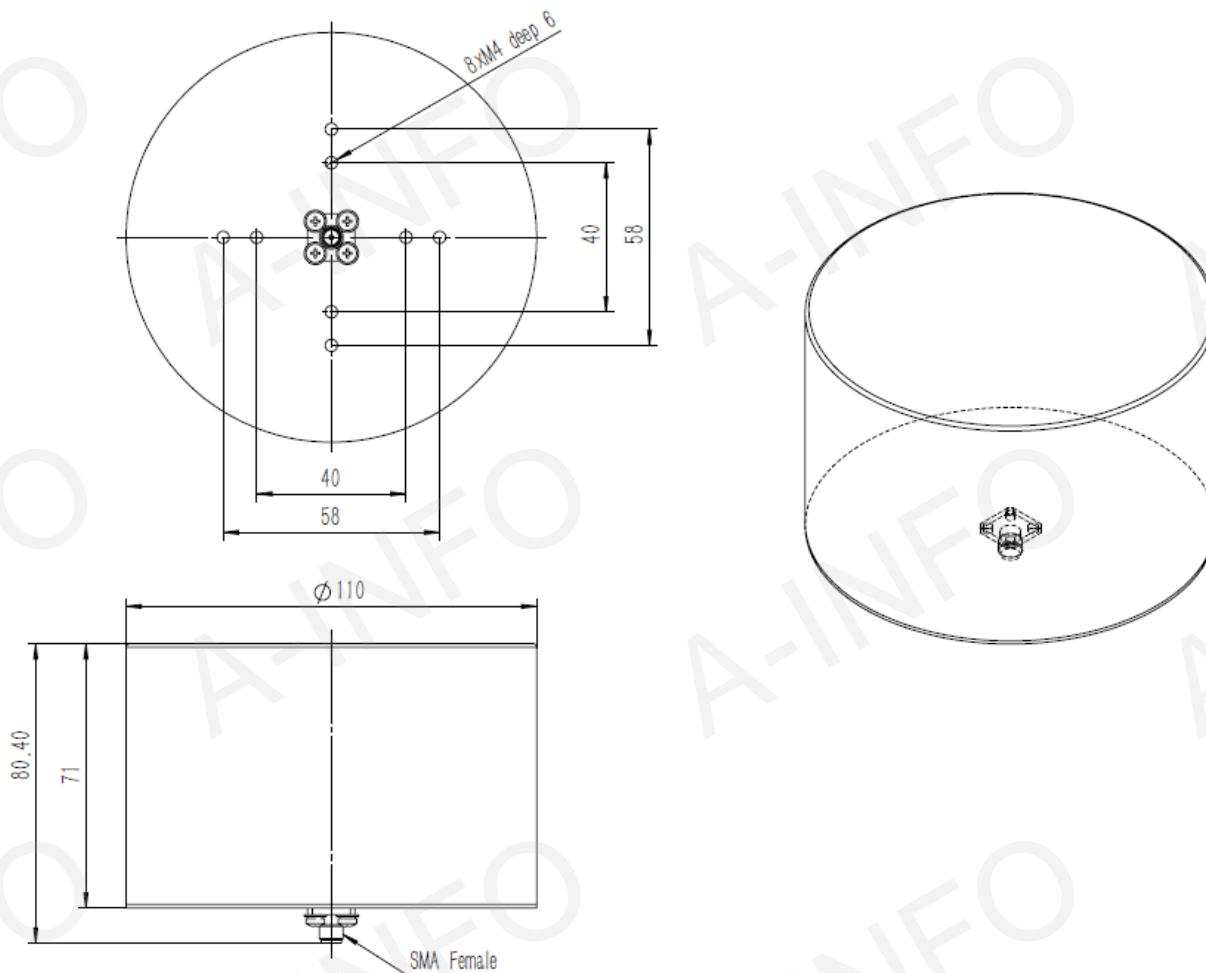

SMA Female Output with round type mounting bracket

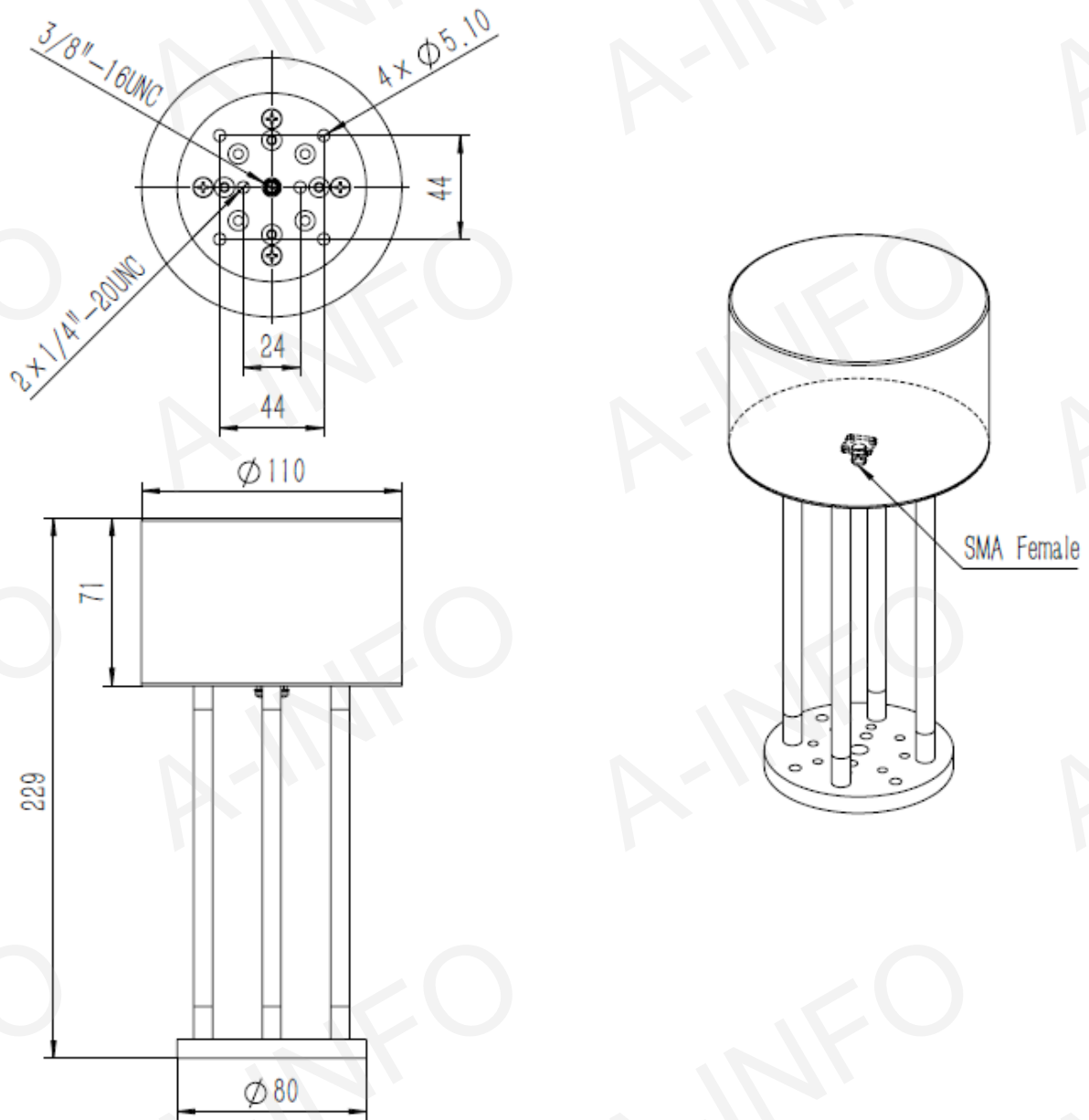

Test Results

1. Gain

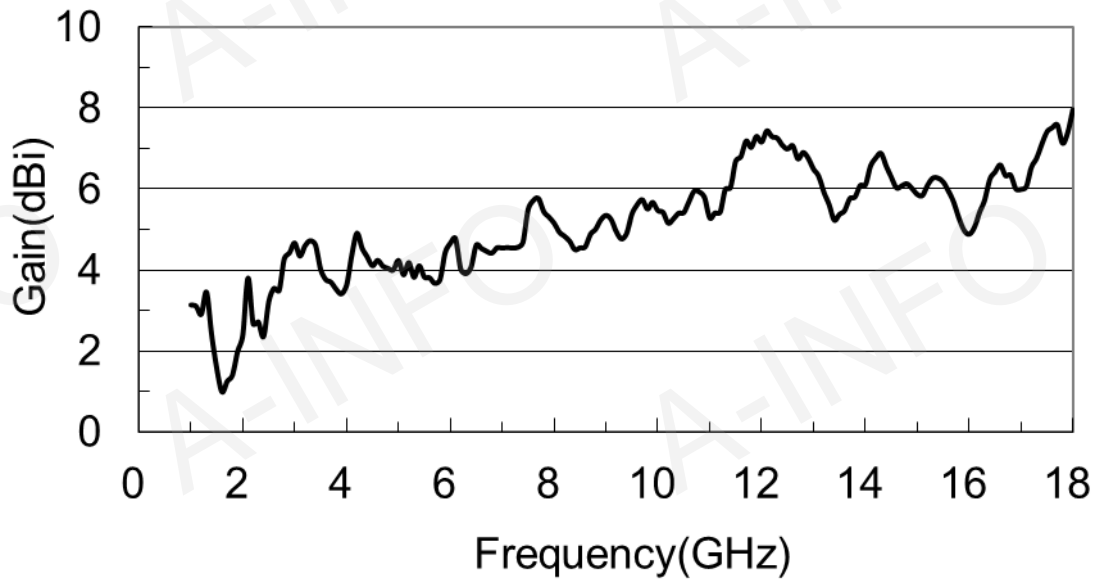

2. VSWR

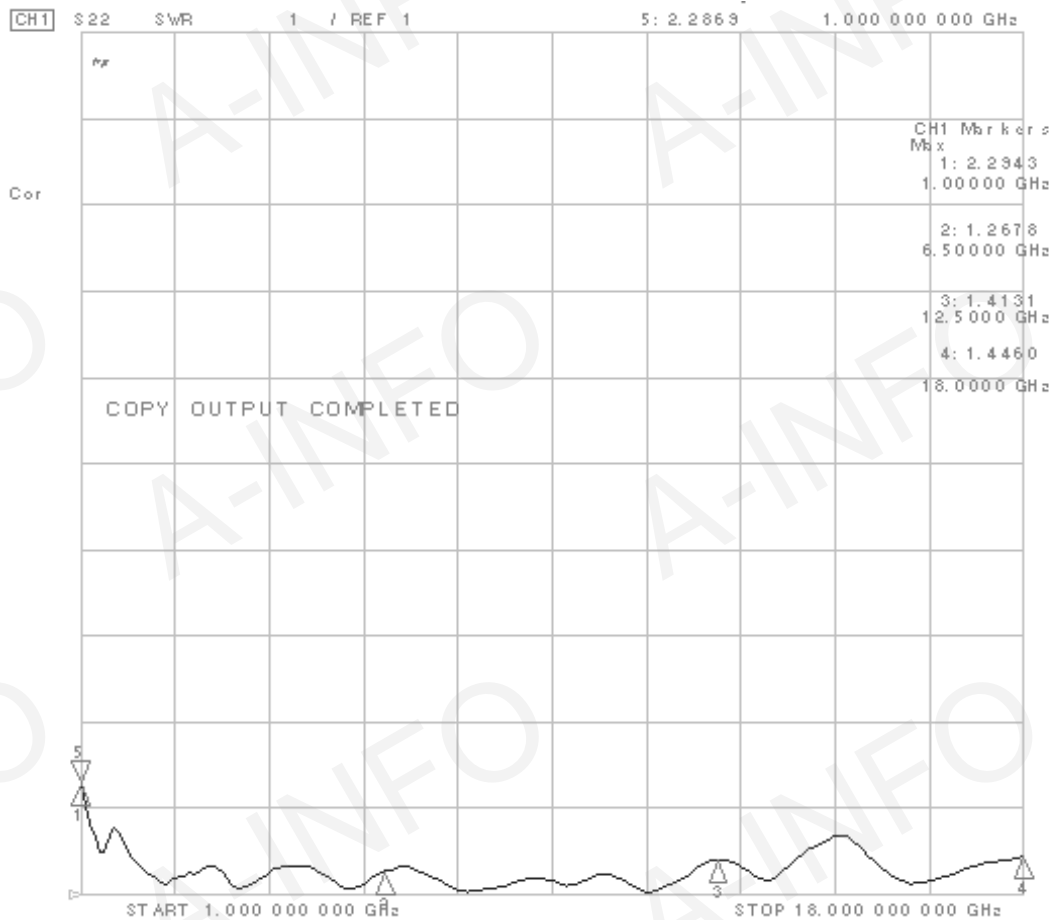

3. Pattern

