

Technical Specification

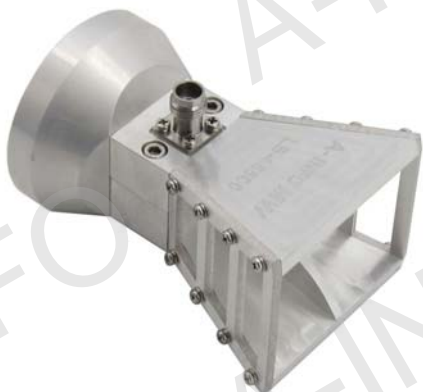

Frequency Range(GHz)	4.5 – 50.0
Gain(dB)	13 Typ.
Polarization	Linear
3dB Beamwidth(deg)	E Plane: 116 - 12
	H Plane: 92 - 9
Cross Pol. Isolation(dB)	35 Typ.
VSWR	1.5:1 Typ.
	2.0:1 Max.
Connector	2.4mm-Female
Power Handling(W)	10 Max. CW
Material	Al
Size(mm)	65 x 43.8 x 41.3
Net Weight(Kg)	0.1 Around

Outline Drawing (Size: mm)

2.4mm Female Output

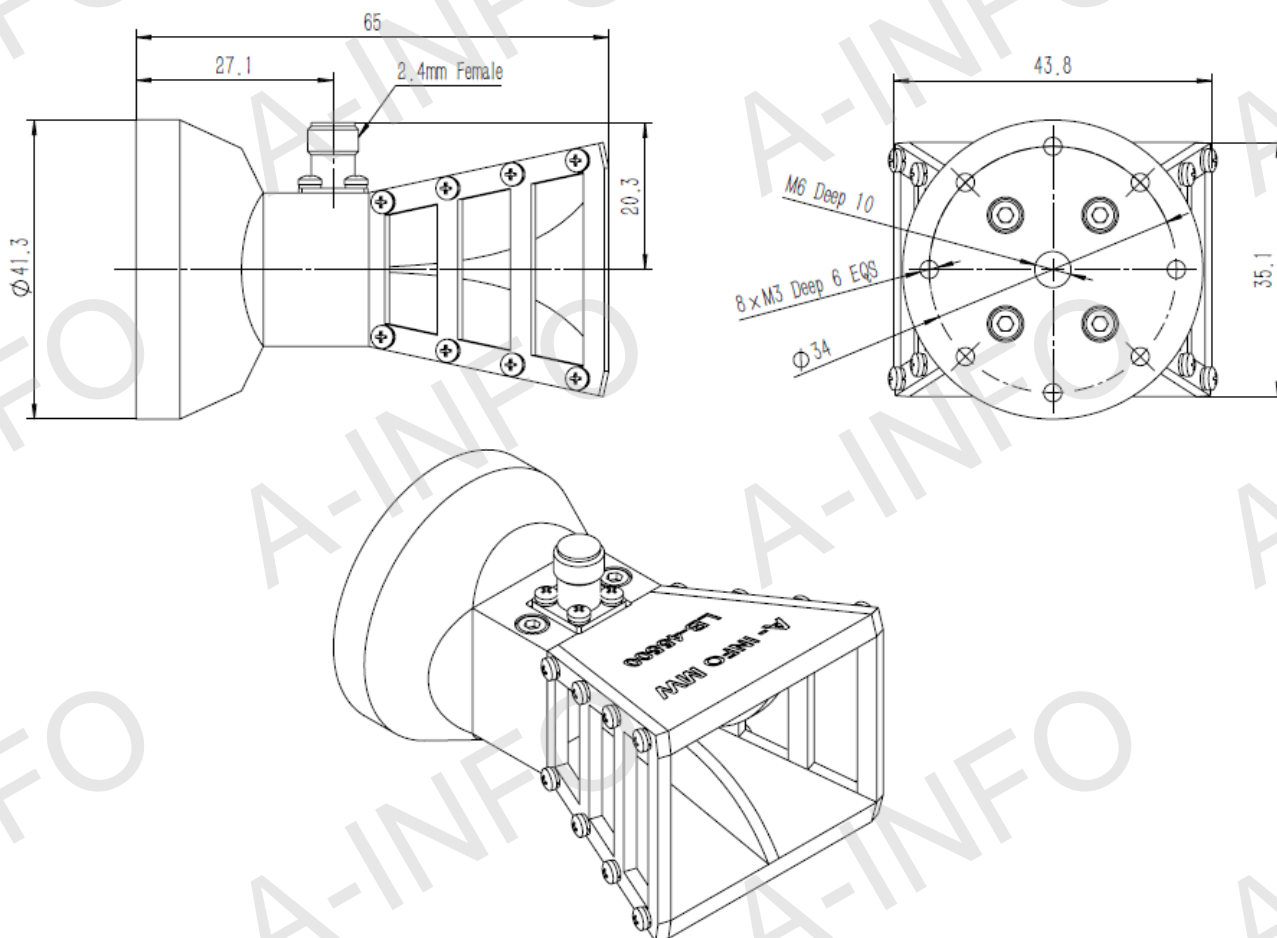

AINFO Inc.

Page 1 of 13

China(Beijing):
China(Chengdu):
USA :

Tel: (+86) 10-6266-7326,
Tel: (+86) 28-8519-2786,
Tel: (+1) 949-639-9688,

(+86) 10-6266-7327
(+86) 28-8519-3044
(+1) 949-639-9608

Fax: (+86) 10-6266-7379
Fax: (+86) 28-8519-3068
Fax: (+1) 949-639-9670

Website: www.ainfoinc.com
Email: sales@ainfoinc.com

2.4mm Female Output with L type Mounting Bracket

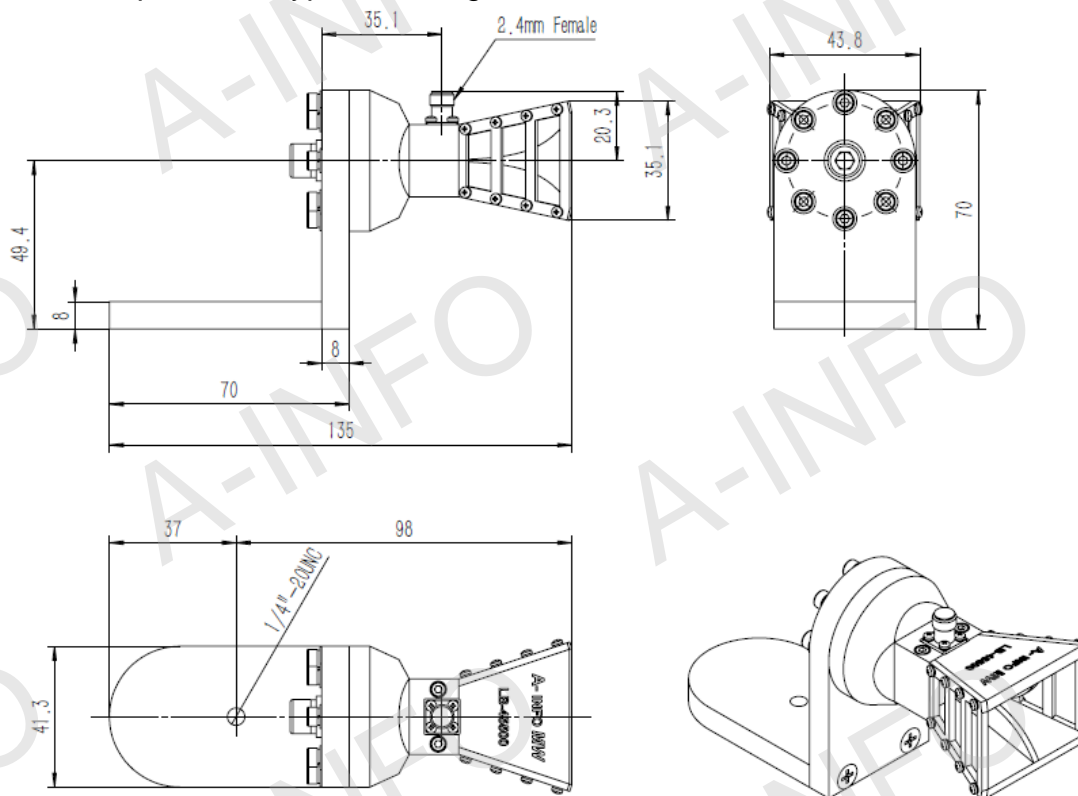

2.4mm Female Output with Radome

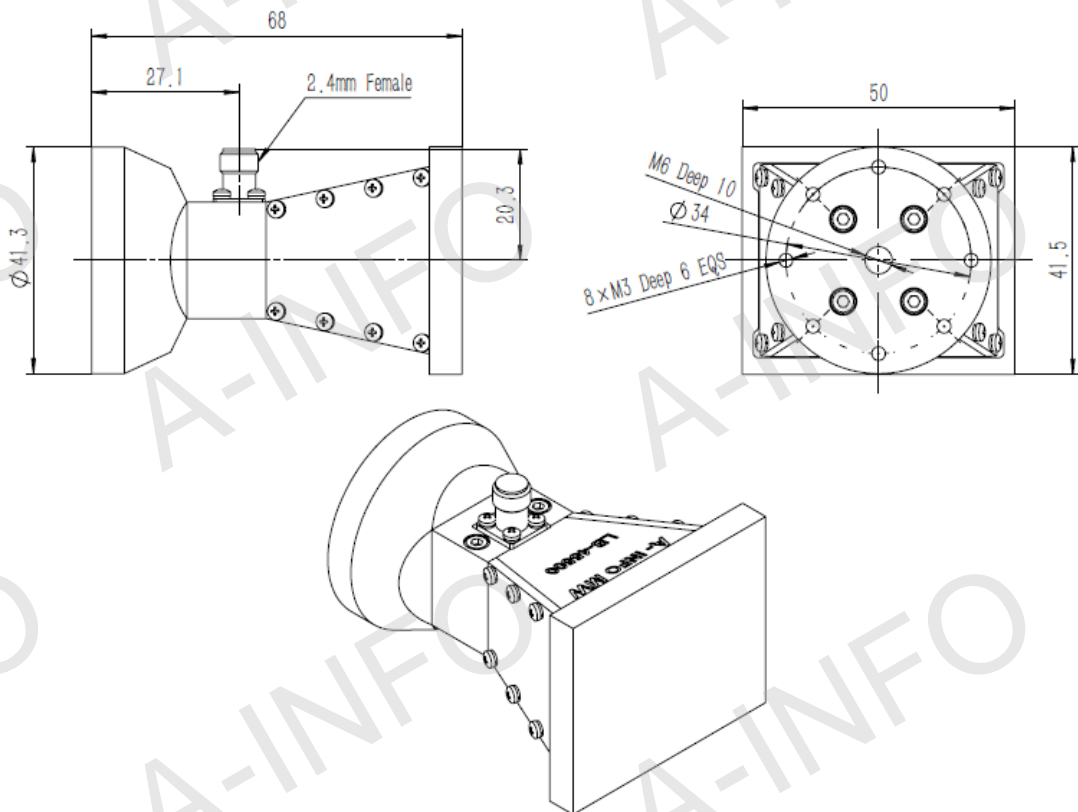

2.4mm Female Output with L type Mounting Bracket and Radome

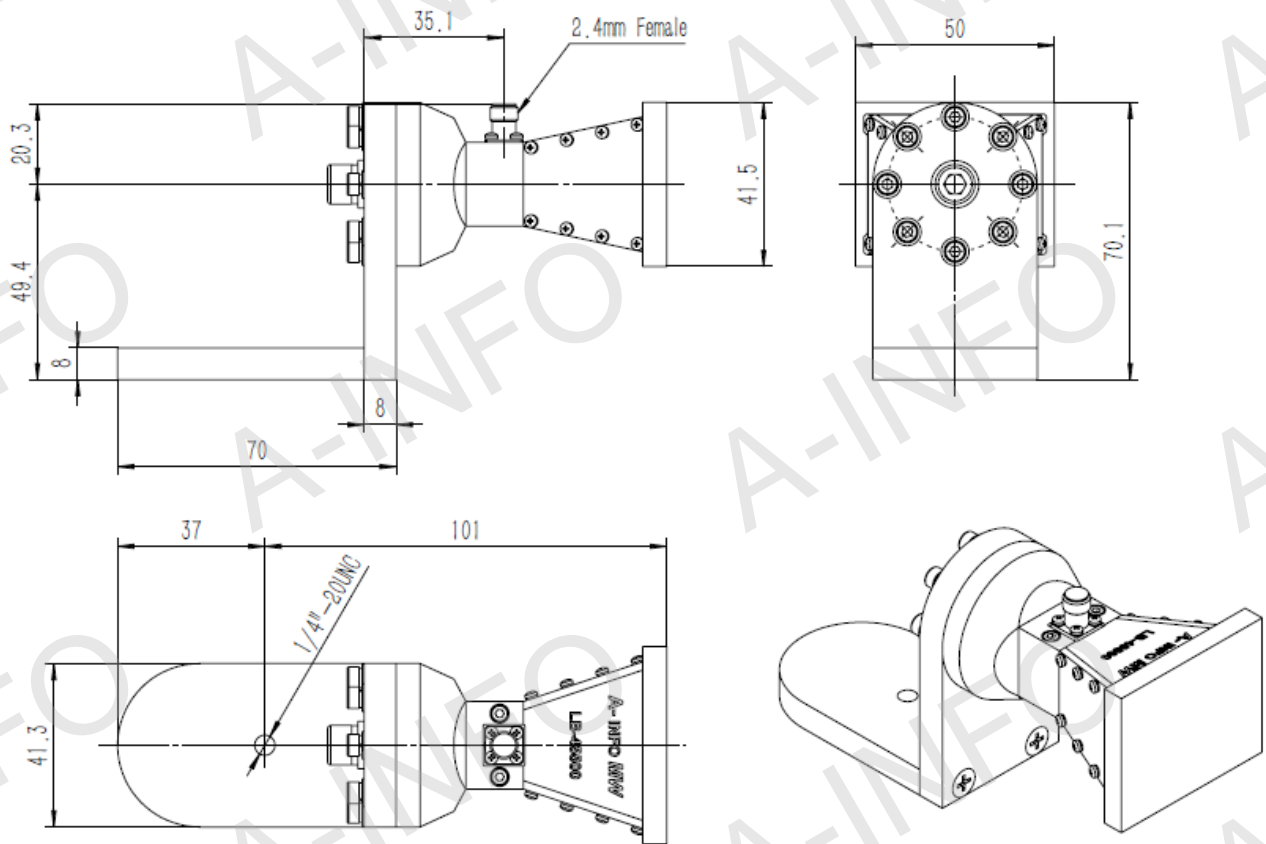

Test Results

1. Gain

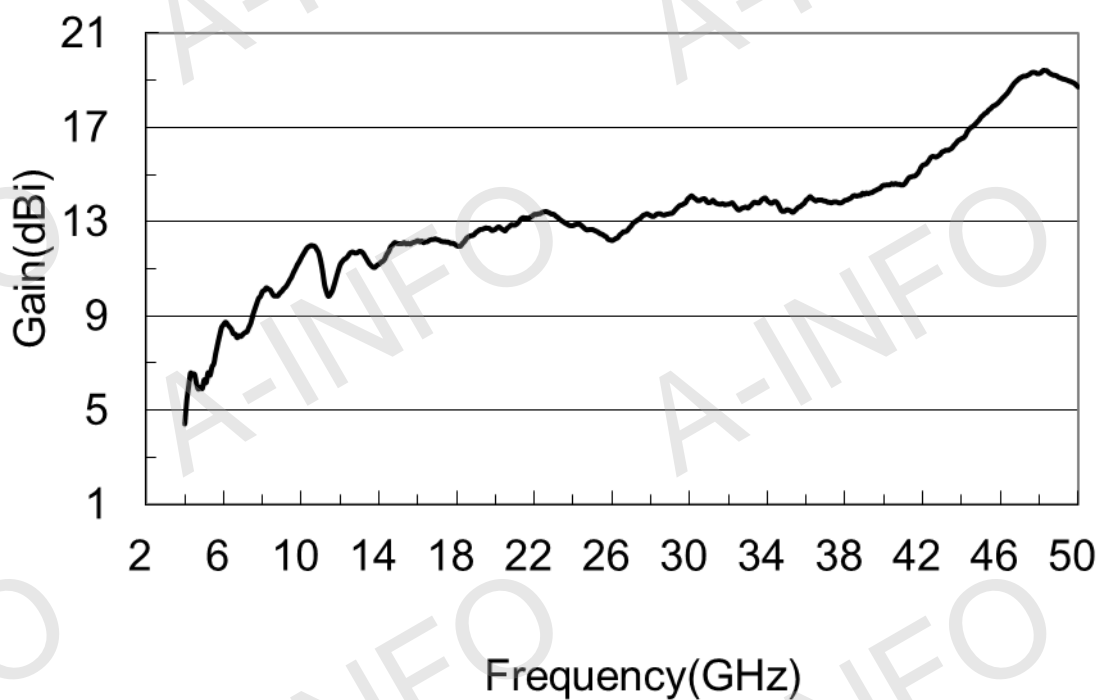

2. Antenna Factor

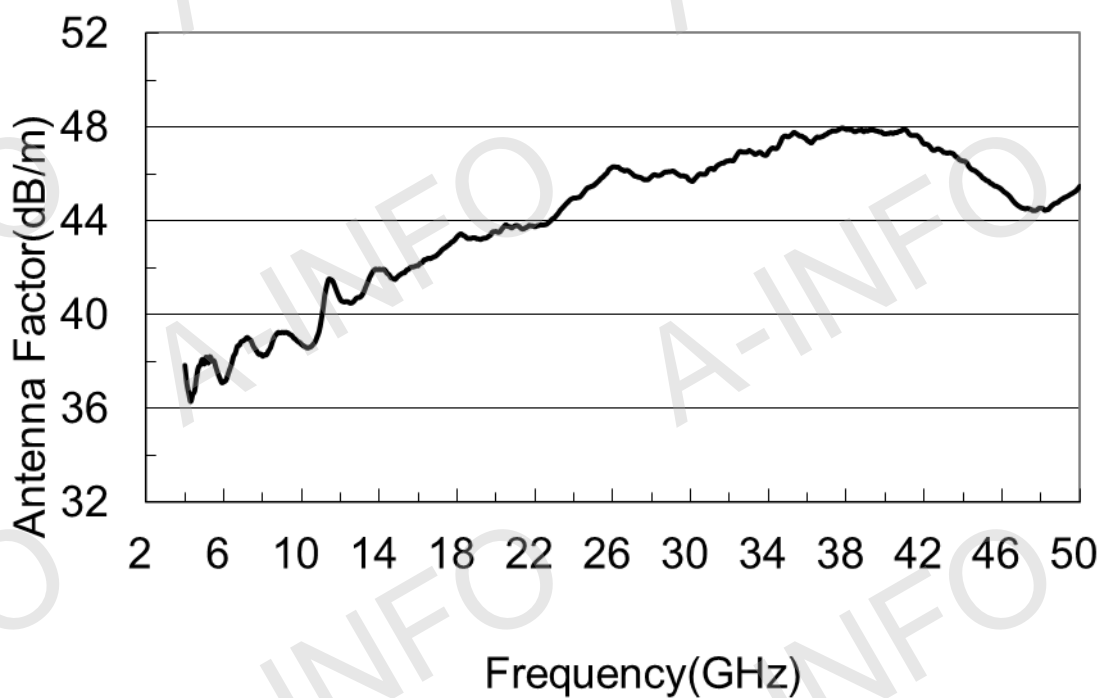

3. VSWR

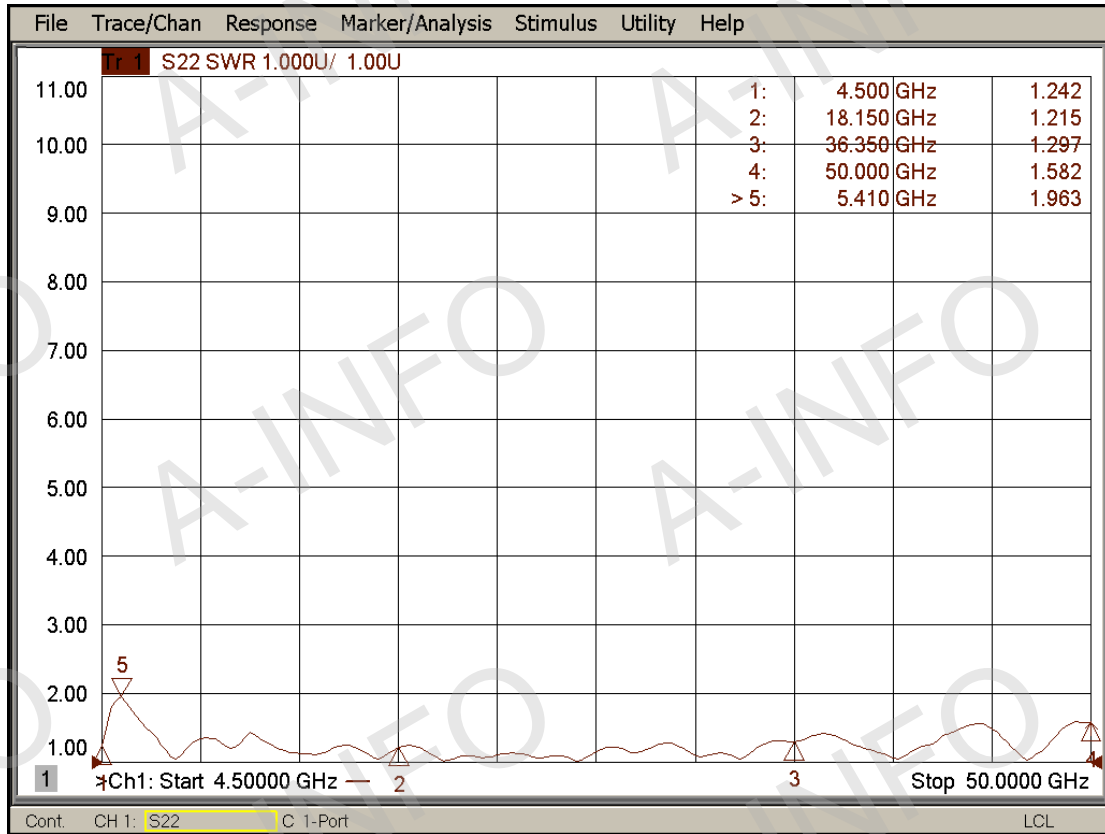

4. Cross Polarization Isolation

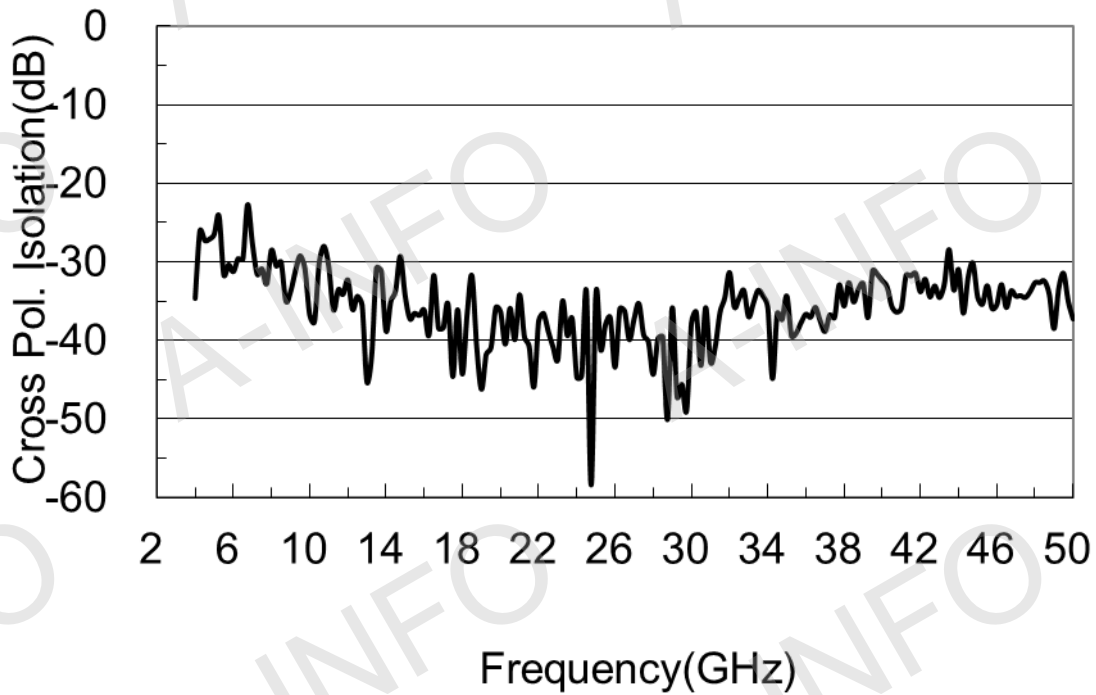

5. Pattern

