

## Low Noise and High Dynamic Range Packaged GaAs FETs

### FEATURES

- 0.5 dB Typical Noise Figure at 12 GHz
- High Associated Gain:  $G_a = 12$  dB Typical at 12 GHz
- 21.5 dBm Typical Power at 12 GHz
- 12 dB Typical Linear Power Gain at 12 GHz
- Breakdown Voltage :  $BV_{DGO} \geq 9$  V
- $L_g = 0.25 \mu\text{m}$ ,  $W_g = 300 \mu\text{m}$
- Tight  $V_p$  ranges control
- High RF input power handling capability
- 100 % DC Tested
- Micro-X Metal Ceramic Package

### PHOTO ENLARGEMENT



### DESCRIPTION

The TC2281 is a high performance field effect transistor housed in a ceramic micro-x package with TC1201 PHEMT Chip. It has very low noise figure, high associated gain and high dynamic range that makes this device suitable for use in low noise amplifiers. All devices are 100 % DC tested to assure consistent quality.

### ELECTRICAL SPECIFICATIONS ( $T_A=25^\circ\text{C}$ )

Symbol	Conditions	MIN	TYP	MAX	UNIT
NF	Noise Figure at $V_{DS} = 4$ V, $I_{DS} = 25$ mA, $f = 12$ GHz		0.5	0.7	dB
$G_a$	Associated Gain at $V_{DS} = 4$ V, $I_{DS} = 25$ mA, $f = 12$ GHz	10	12		dB
$P_{1dB}$	Output Power at 1dB Gain Compression Point, $f = 12$ GHz $V_{DS} = 6$ V, $I_{DS} = 40$ mA	20.5	21.5		dBm
$G_L$	Linear Power Gain, $f = 12$ GHz $V_{DS} = 6$ V, $I_{DS} = 40$ mA	11	12		dB
$I_{DSS}$	Saturated Drain-Source Current at $V_{DS} = 2$ V, $V_{GS} = 0$ V		90		mA
$g_m$	Transconductance at $V_{DS} = 2$ V, $V_{GS} = 0$ V		100		mS
$V_p$	Pinch-off Voltage at $V_{DS} = 2$ V, $I_D = 0.6$ mA		-1.0*		Volts
$BV_{DGO}$	Drain-Gate Breakdown Voltage at $I_{DGO} = 0.15$ mA	9	12		Volts
$R_{th}$	Thermal Resistance		150		$^\circ\text{C}/\text{W}$

### ABSOLUTE MAXIMUM RATINGS ( $T_A=25^\circ\text{C}$ ) TYPICAL NOISE PARAMETERS ( $T_A=25^\circ\text{C}$ )

Symbol	Parameter	Rating
$V_{DS}$	Drain-Source Voltage	7.0 V
$V_{GS}$	Gate-Source Voltage	-3.0 V
$I_{DS}$	Drain Current	$I_{DSS}$
$I_{GS}$	Gate Current	300 $\mu\text{A}$
$P_{in}$	RF Input Power, CW	21 dBm
$P_T$	Continuous Dissipation	400 mW
$T_{CH}$	Channel Temperature	175 $^\circ\text{C}$
$T_{STG}$	Storage Temperature	- 65 $^\circ\text{C}$ to +175 $^\circ\text{C}$

$V_{DS} = 4$  V,  $I_{DS} = 25$  mA

Frequency (GHz)	$NF_{opt}$ (dB)	$G_A$ (dB)	$\Gamma_{opt}$		Rn/50
			MAG	ANG	
2	0.35	24.8	0.83	38	0.40
4	0.38	19.2	0.73	75	0.32
6	0.40	16.0	0.66	105	0.26
8	0.46	13.7	0.60	130	0.21
10	0.52	12.1	0.55	154	0.17
12	0.57	11.1	0.50	180	0.15
14	0.69	10.6	0.47	-153	0.14
16	0.82	10.4	0.44	-121	0.15
18	1.02	10.3	0.40	-81	0.17

\* For the tight control of the pinch-off voltage range, we divide TC2281 into 3 model numbers to fit customer design requirement

(1)TC2281P0710 :  $V_p = -0.7$  V to  $-1.0$  V (2)TC2281P0811 :  $V_p = -0.8$  V to  $-1.1$  V (3)TC2281P0912 :  $V_p = -0.9$  V to  $-1.2$  V

If required, customer can specify the requirement in purchasing document. For special  $V_p$  requirement, please contact factory for details.

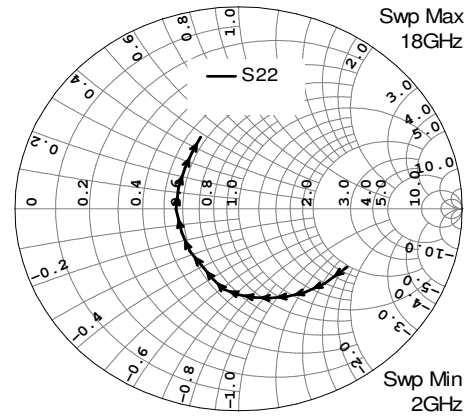
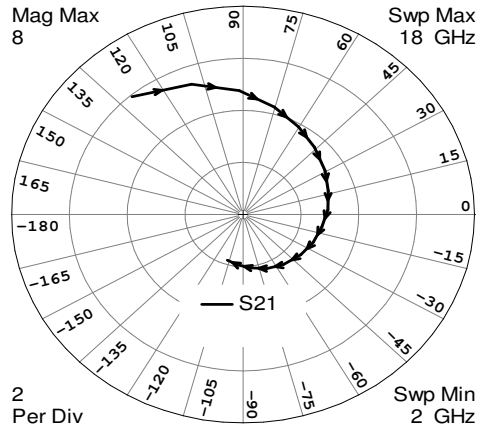
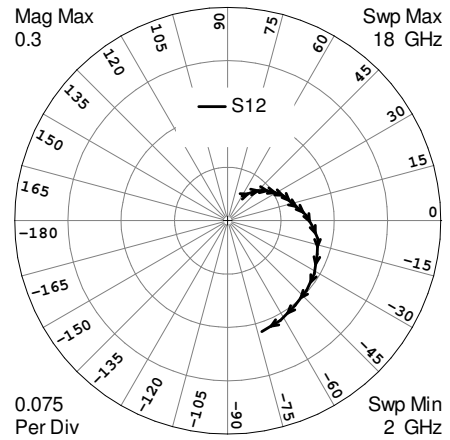
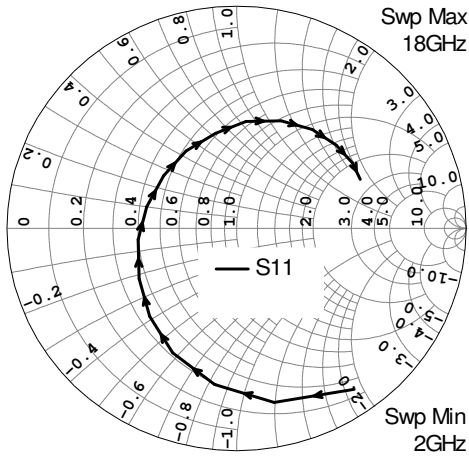
**TYPICAL SCATTERING PARAMETERS (T<sub>A</sub>=25 °C) V<sub>DS</sub> = 4 V, I<sub>DS</sub> = 25 mA**

FREQUENCY (GHz)	S11		S21		S12		S22	
	MAG	ANG	MAG	ANG	MAG	ANG	MAG	ANG
2	0.8869	-54.70	5.9336	130.29	0.0400	59.95	0.5642	-30.68
3	0.7993	-78.21	5.3111	109.57	0.0545	48.51	0.5334	-44.07
4	0.7083	-97.81	4.7547	91.56	0.0655	40.93	0.5079	-54.31
5	0.6254	-116.37	4.2734	75.40	0.0732	34.06	0.4855	-63.34
6	0.5471	-133.73	3.8827	60.41	0.0814	27.67	0.4635	-72.26
7	0.4806	-151.99	3.5669	46.33	0.0884	21.99	0.4437	-81.23
8	0.4322	-173.31	3.2902	30.77	0.0938	14.72	0.4234	-90.67
9	0.4031	165.82	3.0788	17.26	0.1028	9.21	0.4026	-99.73
10	0.3964	143.17	2.9371	3.76	0.1109	3.92	0.3667	-108.08
11	0.4120	122.20	2.7621	-9.78	0.1204	-4.41	0.3252	-120.67
12	0.4378	102.07	2.6532	-23.68	0.1290	-11.33	0.3032	-136.24
13	0.4838	85.15	2.5234	-37.81	0.1345	-20.50	0.2801	-155.17
14	0.5222	68.20	2.3781	-54.18	0.1430	-31.48	0.2801	-179.65
15	0.5540	53.47	2.2318	-68.35	0.1484	-41.37	0.2899	-158.35
16	0.5732	40.71	2.0682	-82.51	0.1521	-51.41	0.3155	139.24
17	0.5847	30.16	1.9420	-95.78	0.1587	-62.11	0.3501	126.15
18	0.5827	22.32	1.8285	-107.14	0.1634	-72.86	0.3946	115.58

\* The data does not include gate, drain and source bond wires.

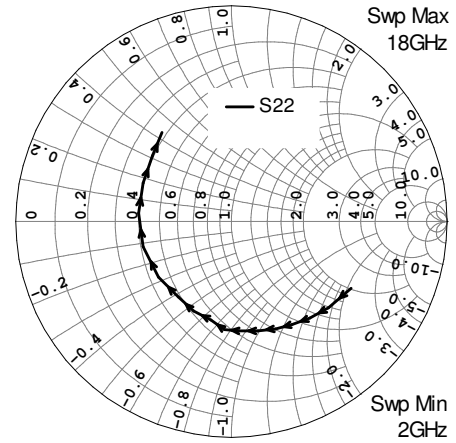
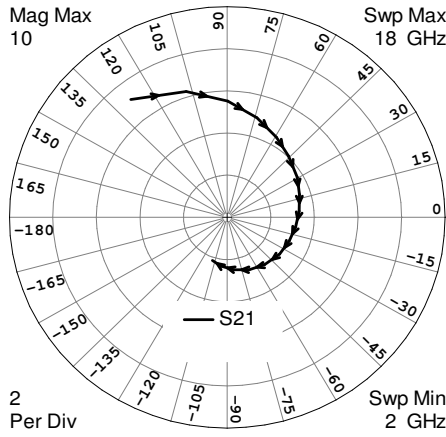
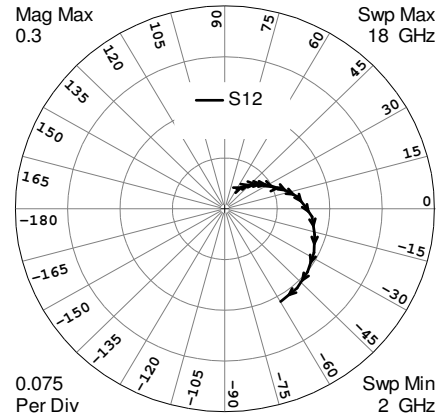
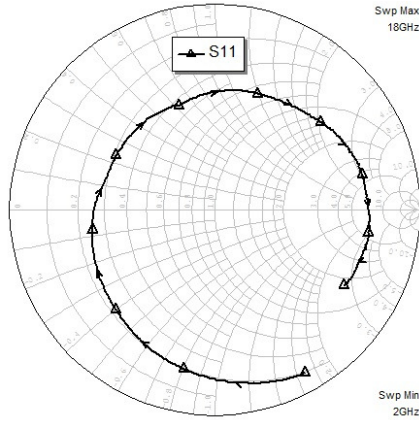
**TYPICAL SCATTERING PARAMETERS (T<sub>A</sub>=25 °C) V<sub>DS</sub> = 6 V, I<sub>DS</sub> = 40 mA**

FREQUENCY (GHz)	S11		S21		S12		S22	
	MAG	ANG	MAG	ANG	MAG	ANG	MAG	ANG
2	0.8647	-55.91	7.1265	128.30	0.0336	59.49	0.6347	-29.17
3	0.7655	-79.05	6.2685	107.44	0.0443	49.73	0.6019	-41.65
4	0.6698	-97.86	5.5240	89.70	0.0525	43.58	0.5761	-50.97
5	0.5840	-115.61	4.9171	73.80	0.0597	37.66	0.5542	-59.45
6	0.5051	-132.32	4.4302	59.27	0.0649	33.80	0.5373	-67.64
7	0.4388	-149.11	4.0457	45.90	0.0712	29.58	0.5212	-76.28
8	0.3884	-169.71	3.7299	30.64	0.0776	23.21	0.5084	-85.86
9	0.3546	170.09	3.4848	18.09	0.0855	21.36	0.5024	-93.69
10	0.3487	148.32	3.3238	4.92	0.0952	14.89	0.4659	-101.80
11	0.3599	127.43	3.1822	-8.19	0.1053	9.93	0.4511	-112.90
12	0.3911	107.42	3.0656	-21.35	0.1144	2.22	0.4287	-125.19
13	0.4354	90.79	2.9729	-35.97	0.1253	-5.51	0.4243	-142.78
14	0.4800	73.19	2.8327	-52.49	0.1343	-16.51	0.4248	-164.13
15	0.5213	58.62	2.6833	-67.82	0.1431	-26.93	0.4327	174.68
16	0.5488	45.57	2.4946	-82.91	0.1508	-38.16	0.4465	156.34
17	0.5630	34.80	2.3323	-96.63	0.1564	-48.63	0.4773	140.19
18	0.5661	26.37	2.1540	-108.40	0.1588	-59.70	0.5224	127.91

\*The data does not include gate, drain and source bond wires.

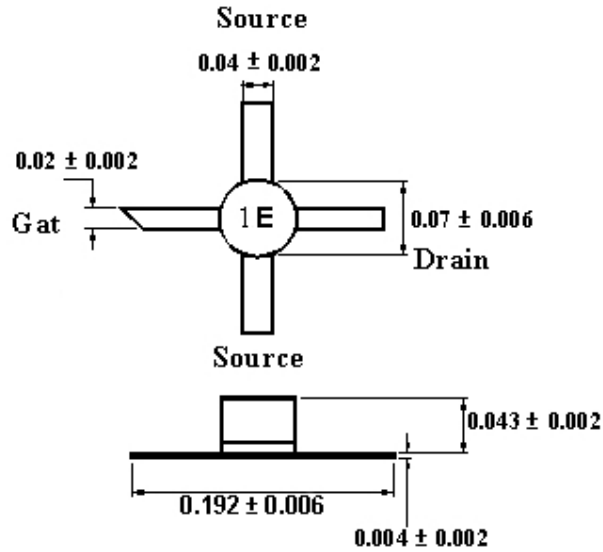
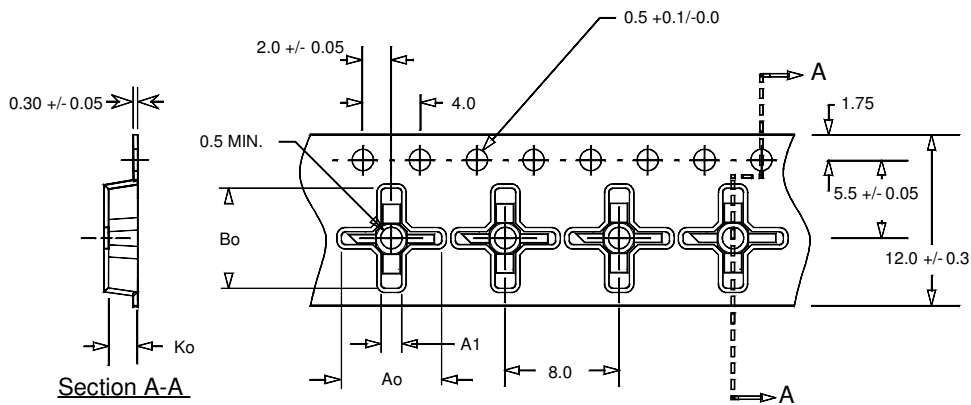
**OUTLINE DIMENSIONS (Unit : inch)**

**Tape & Reel Package Orientation (Unit :mm)**

Ao = 7.0 mm  
 A1 = 1.45 mm  
 Bo = 7.0 mm  
 B1 = 0.9 mm  
 Ko = 2.0 mm

Standard Reel Size	7"
Standard Reel Quantity	1000