

## Low Noise and High Dynamic Range Packaged GaAs FETs

### FEATURES

- 0.5 dB Typical Noise Figure at 12 GHz
- High Associated Gain:  $G_a = 12$  dB Typical at 12 GHz
- 18.5 dBm Typical Power at 12 GHz
- 13 dB Typical Linear Power Gain at 12 GHz
- Breakdown Voltage :  $BV_{DGO} \geq 9V$
- $L_g = 0.25 \mu m$ ,  $W_g = 160 \mu m$
- Tight  $V_p$  ranges control
- High RF input power handling capability
- 100 % DC Tested
- Micro-X Metal Ceramic Package

### PHOTO ENLARGEMENT



### DESCRIPTION

The TC2181 is a high performance field effect transistor housed in a ceramic micro-x package with TC1101 PHEMT Chip. It has very low noise figure, high associated gain and high dynamic range that makes this device suitable for use in low noise amplifiers. All devices are 100 % DC tested to assure consistent quality.

### ELECTRICAL SPECIFICATIONS ( $T_A=25^\circ C$ )

Symbol	CONDITIONS	MIN	TYP	MAX	UNIT
NF	Noise Figure at $V_{DS} = 2$ V, $I_{DS} = 10$ mA, $f = 12$ GHz		0.5	0.7	dB
$G_a$	Associated Gain at $V_{DS} = 2$ V, $I_{DS} = 10$ mA, $f = 12$ GHz	10	12		dB
$P_{1dB}$	Output Power at 1dB Gain Compression Point, $f = 12$ GHz $V_{DS} = 6$ V, $I_{DS} = 25$ mA	17.5	18.5		dBm
$G_L$	Linear Power Gain, $f = 12$ GHz $V_{DS} = 6$ V, $I_{DS} = 25$ mA	11	13		dB
$I_{DSS}$	Saturated Drain-Source Current at $V_{DS} = 2$ V, $V_{GS} = 0$ V		48		mA
$g_m$	Transconductance at $V_{DS} = 2$ V, $V_{GS} = 0$ V		55		mS
$V_p$	Pinch-off Voltage at $V_{DS} = 2$ V, $I_D = 0.32$ mA		-1.0*		Volts
$BV_{DGO}$	Drain-Gate Breakdown Voltage at $I_{DGO} = 0.08$ mA	9	12		Volts
$R_{th}$	Thermal Resistance		250		$^\circ C/W$

### ABSOLUTE MAXIMUM RATINGS ( $T_A=25^\circ C$ )

Symbol	Parameter	Rating
$V_{DS}$	Drain-Source Voltage	7.0 V
$V_{GS}$	Gate-Source Voltage	-3.0 V
$I_{DS}$	Drain Current	$I_{DSS}$
$I_{GS}$	Gate Current	160 $\mu A$
$P_{in}$	RF Input Power, CW	18 dBm
$P_T$	Continuous Dissipation	150 mW
$T_{CH}$	Channel Temperature	175 $^\circ C$
$T_{STG}$	Storage Temperature	- 65 $^\circ C$ to +175 $^\circ C$

### TYPICAL NOISE PARAMETERS ( $T_A=25^\circ C$ )

$V_{DS} = 2$  V,  $I_{DS} = 10$  mA

Frequency (GHz)	NF <sub>opt</sub> (dB)	$G_A$ (dB)	$\Gamma_{opt}$		Rn/50
			MAG	ANG	
2	0.33	18.4	1.00	15	0.42
4	0.35	16.8	0.86	32	0.36
6	0.37	15.2	0.70	53	0.28
8	0.40	13.8	0.53	79	0.20
10	0.46	12.5	0.39	112	0.12
12	0.52	11.5	0.29	153	0.09
14	0.61	11.0	0.26	202	0.08
16	0.77	10.9	0.32	262	0.11
18	0.95	10.6	0.51	332	0.24

\* For the tight control of the pinch-off voltage range, we divide TC2181 into 3 model numbers to fit customer design requirement

(1)TC2181P0710 :  $V_p = -0.7V$  to  $-1.0V$  (2)TC2181P0811 :  $V_p = -0.8V$  to  $-1.1V$  (3)TC2181P0912 :  $V_p = -0.9V$  to  $-1.2V$

If required, customer can specify the requirement in purchasing document. For special  $V_p$  requirement, please contact factory for details.

**TYPICAL SCATTERING PARAMETERS (T<sub>A</sub>=25 °C)**

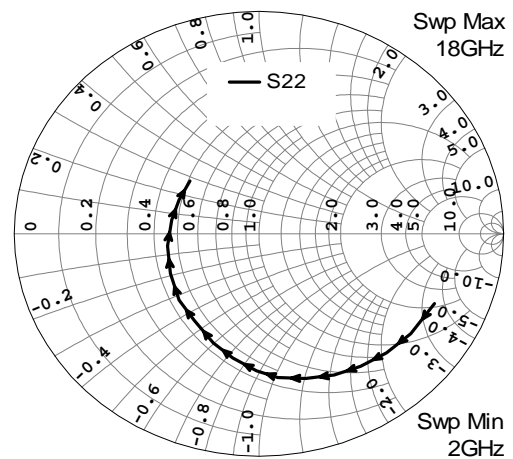
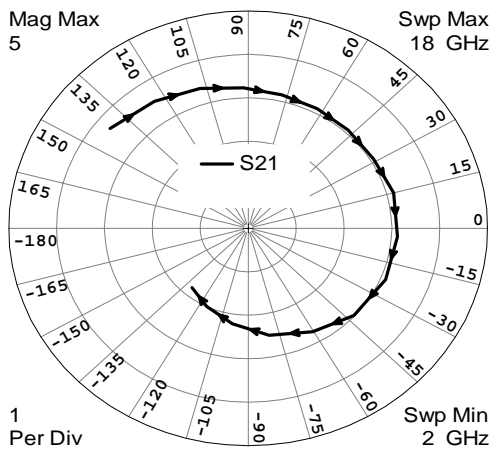
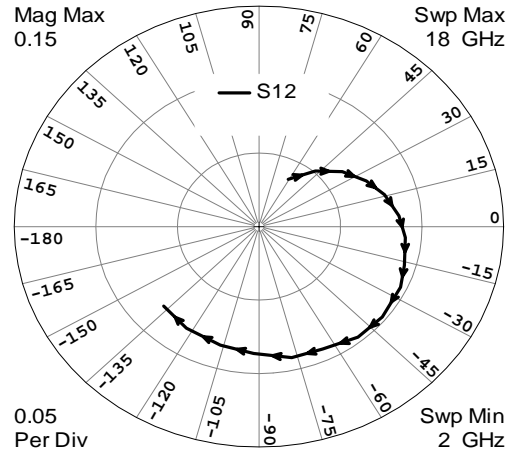
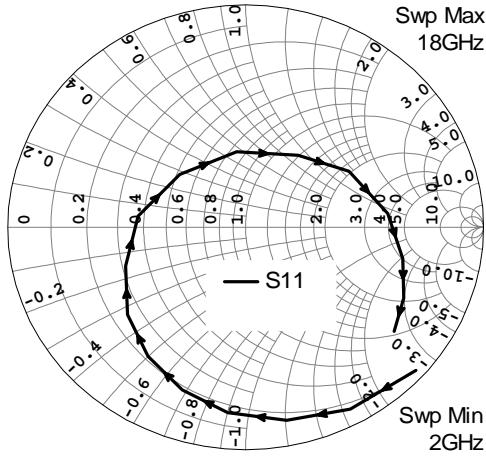
 V<sub>DS</sub> = 2 V, I<sub>DS</sub> = 10 mA

FREQUENCY (GHz)	S11		S21		S12		S22	
	MAG	ANG	MAG	ANG	MAG	ANG	MAG	ANG
2	0.9628	-42.01	3.6830	141.51	0.0369	60.76	0.7839	-23.66
3	0.9290	-61.72	3.5155	123.73	0.0512	47.51	0.7662	-35.92
4	0.8850	-78.83	3.3714	107.39	0.0632	36.12	0.7479	-45.77
5	0.8363	-95.16	3.2341	91.69	0.0727	25.30	0.7265	-55.17
6	0.7790	-109.98	3.1485	77.11	0.0800	15.65	0.7060	-64.15
7	0.7101	-125.31	3.1044	62.36	0.0862	4.83	0.6784	-73.69
8	0.6325	-141.60	3.0739	47.17	0.0901	-4.80	0.6513	-83.26
9	0.5336	-160.93	3.0671	31.34	0.0929	-16.52	0.6154	-90.94
10	0.4551	173.73	3.1463	15.00	0.0960	-25.42	0.5681	-100.85
11	0.3646	139.38	3.1229	-3.47	0.0975	-39.11	0.5247	-110.79
12	0.3414	96.27	3.1032	-22.28	0.0967	-51.12	0.4703	-124.31
13	0.3916	55.69	2.9852	-42.22	0.0921	-64.82	0.4424	-137.54
14	0.5021	30.09	2.7319	-60.52	0.0914	-77.33	0.4033	-153.71
15	0.6006	5.98	2.4944	-79.87	0.0864	-92.13	0.3775	-171.58
16	0.6761	-12.09	2.2205	-98.64	0.0840	-106.37	0.3620	170.12
17	0.7365	-25.55	1.9949	-115.65	0.0822	-122.68	0.3602	155.01
18	0.7802	-36.92	1.7959	-130.79	0.0795	-137.17	0.3676	139.99

**TYPICAL SCATTERING PARAMETERS (T<sub>A</sub>=25 °C)**

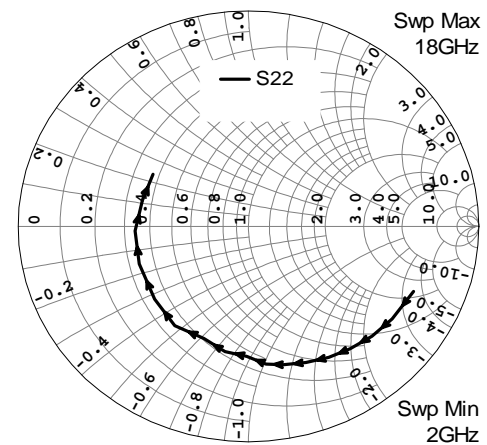
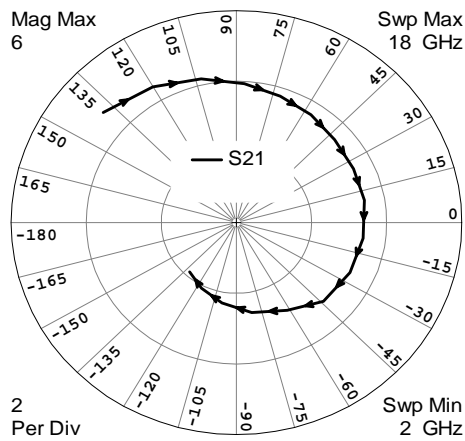
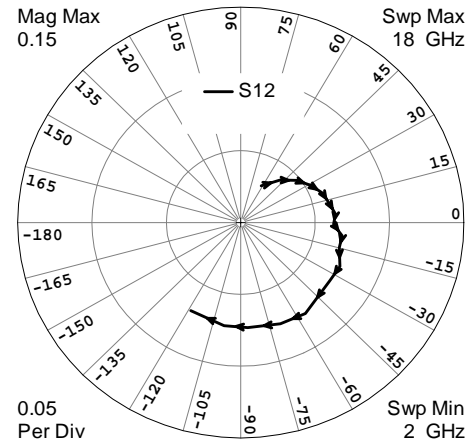
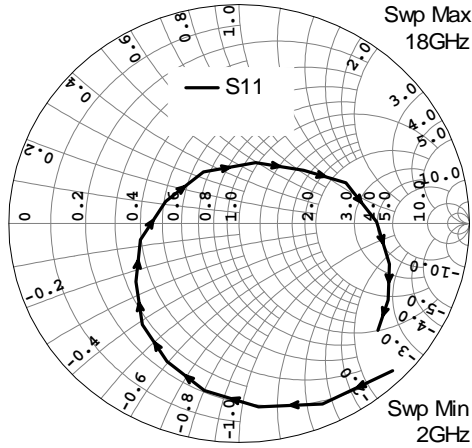
 V<sub>DS</sub> = 6 V, I<sub>DS</sub> = 25 mA

FREQUENCY (GHz)	S11		S21		S12		S22	
	MAG	ANG	MAG	ANG	MAG	ANG	MAG	ANG
2	0.9466	-45.27	4.7204	138.76	0.0290	61.77	0.7774	-22.86
3	0.8992	-66.27	4.4365	120.08	0.0396	48.23	0.7580	-34.56
4	0.8408	-84.20	4.1742	103.05	0.0477	37.94	0.7395	-43.57
5	0.7773	-101.14	3.9371	86.89	0.0537	28.59	0.7191	-52.08
6	0.7030	-116.48	3.7614	71.87	0.0586	20.40	0.7011	-60.22
7	0.6246	-132.27	3.6415	57.05	0.0609	12.76	0.6793	-68.36
8	0.5210	-149.31	3.5115	41.83	0.0639	5.41	0.6598	-76.76
9	0.4356	-170.31	3.4665	26.02	0.0625	-1.28	0.6438	-83.16
10	0.3339	162.28	3.4607	10.46	0.0689	-7.68	0.6037	-90.66
11	0.2823	123.36	3.4022	-7.55	0.0685	-14.81	0.5905	-99.89
12	0.2873	75.57	3.3375	-25.01	0.0733	-24.74	0.5557	-110.39
13	0.3712	40.99	3.2126	-43.89	0.0722	-34.16	0.5615	-124.83
14	0.4997	21.87	2.8277	-61.45	0.0769	-55.60	0.5292	-140.37
15	0.5974	0.68	2.5760	-80.86	0.0754	-69.38	0.5056	-159.87
16	0.6783	-15.81	2.3064	-99.52	0.0733	-86.29	0.4924	-177.54
17	0.7357	-28.35	2.0749	-116.62	0.0726	-98.81	0.4759	165.28
18	0.7748	-38.97	1.8691	-131.76	0.0701	-118.72	0.4796	149.77

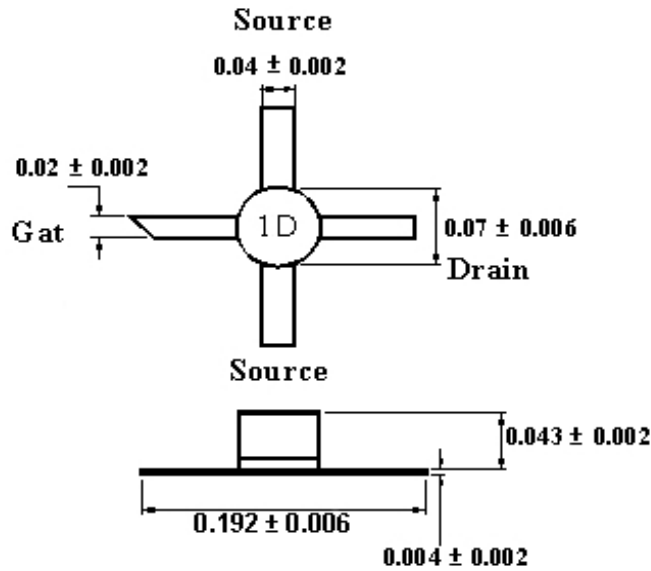
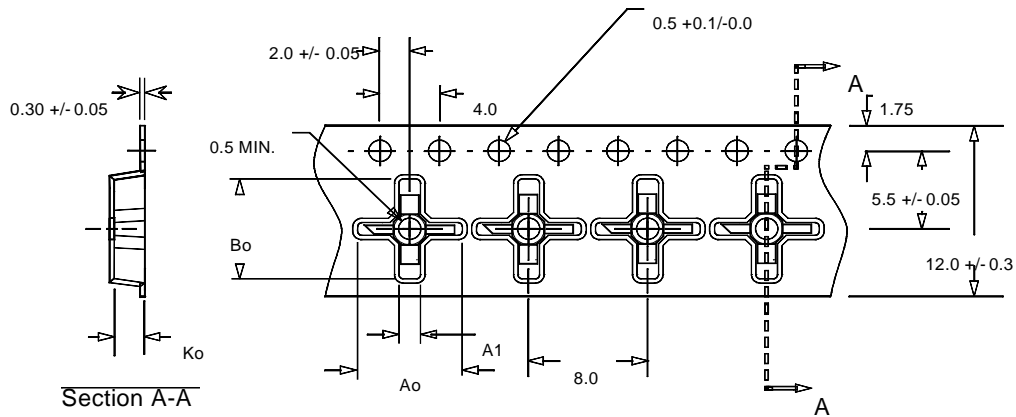
**OUTLINE DIMENSIONS (Unit: inch)**

**Tape & Reel Package Orientation (Unit: mm)**

Ao = 7.0 mm  
 A1 = 1.45 mm  
 Bo = 7.0 mm  
 B1 = 0.9 mm  
 Ko = 2.0 mm

Standard Reel Size	7"
Standard Reel Quantity	1000