

▪ **Outline Dimension Drawing**

Dimensions: mm[inch]

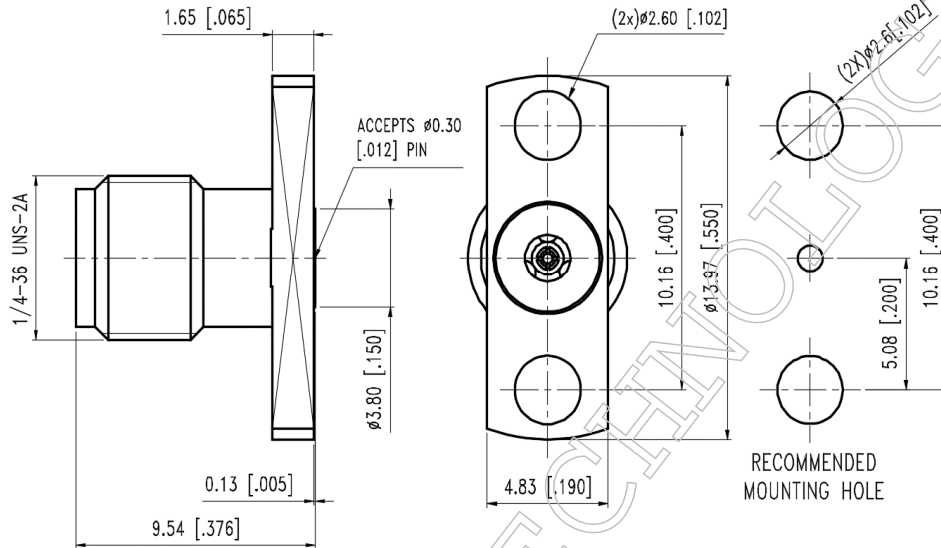

▪ **Material Specification**

Description	Material	Plating
Body*2	Stainless steel	Passivate
Contact*2	BeCu	Gold
Dielectric	High performance application material	

In the effort to improve our products, we reserve the right to make changes judged to be necessary



▪ **Electrical Specification**

Description		Description	
Impedance	50 Ω	Insulation Resistance	5000 M Ω Min.
Frequency	40 GHz	Inner Contact Resistance	3 m Ω Max.
VSWR	1.3 Max.	Outer Contact Resistance	2 m Ω Max.
Insertion Loss	0.2 dB Max.		
Voltage Rating	250 Vrms Max.		
Dielectric Withstanding Voltage	500 Vrms Max.		

▪ **Mechanical Specification**

Description		Description	
Center Contact		Recommended Torque	7~9 in. lbs
Axial Force-Mating End	6 lbs.	Coupling Test Torque	15.0 in. lbs
Axial Force-Opposite End	6 lbs.		
Connector Durability	500 cycles		
Weight	N/A g		

▪ **Environmental Specification**

Description	
Temperature Min.	-45 $^{\circ}$ C
Temperature Max.	105 $^{\circ}$ C
Hermetic Seal	N/A

In the effort to improve our products, we reserve the right to make changes judged to be necessary