

2-22GHz LNA with AGC

GaAs Monolithic Microwave IC

Description

The CHA3024-QGG is a distributed Low Noise Amplifier with Adjustable Gain Control (AGC) that operates between 2 and 22GHz.

It is designed for a wide range of applications, such as electronic warfare, X and Ku Point to Point Radio, and test instrumentation.

The circuit is manufactured using a 0.15 μ m gate length pHEMT process, with via holes through the substrate, air bridges and optical gate lithography.

The part is supplied as 5x5 QFN package with input and output RF accesses matched to 50 ohms.

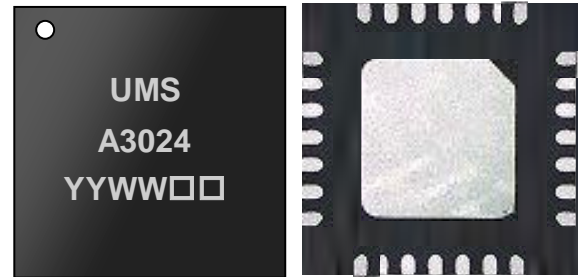

Main Features

- Broadband performances: 2-22GHz
- Typical Linear Gain: 15dB
- Up to 30dB AGC with Vg2
- P1dB: 18dBm
- Psat: 20dBm
- OIP3: 28dBm
- Typical Noise Figure: 3dB
- DC bias: Vd=5V@Id=100mA, Vg1=-0.3V and Vg2=1.7V.
- 28L QFN 5x5

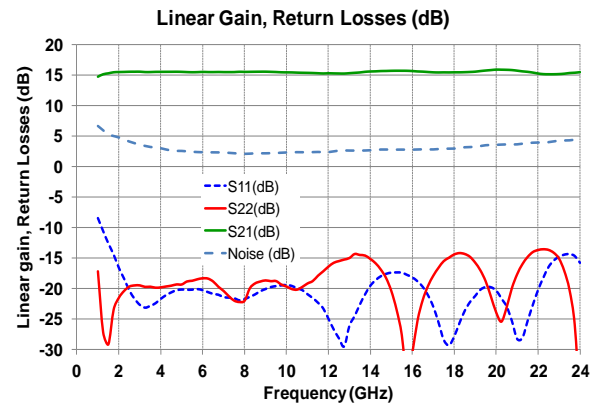

Main Electrical Characteristics

Tamb.= +25°C

Symbol	Parameter	Min	Typ	Max	Unit
Freq	Frequency range	2		22	GHz
Gain	Linear Gain		15		dB
NF	Noise Figure		3		dB
Pout	Output Power @1dB comp.		18		dBm

Electrical Characteristics

Tamb.= +25°C, Vg1 to be set in order to have Idq=100mA, Vg2=1.7V

Symbol	Parameter	Min	Typ	Max	Unit
Freq	Frequency range	2		22	GHz
Gain	Linear Gain		15		dB
ΔG	Gain Control (with Vg2 variation)		30		dB
NF	Noise Figure		3		dB
IRL	Input Return Loss		17		dB
ORL	Output Return Loss		16		dB
P1dB	Output power for 1dB Gain Compression		18		dBm
Psat	Saturated output power		20		dBm
OIP3	Output Third Order Intercept		28		dBm
Idq	Quiescent current on Vd		100		mA
Vd	Supply voltage on Vd	4.5	5	5.5	V
Id	Drain current @3dB gain compression		125		mA

The values are representative of typical "test fixture" measurements as defined on the drawing in paragraph "Proposed Evaluation Board".

Typical Bias Conditions

Tamb.= +25°C

Symbol	Pin	Parameter	Values	Unit
Vg1	13	Gate control1 for the amplifier	-0.4	V
Vg2	1	Gate control2 for the amplifier	1.7	V
Vd	25	Drain Voltage	5	V

The associated drain current with no RF input power is Idq=100mA

This typical bias is recommended in order to get the best compromise between output power, linearity and Noise Figure performance vs. Temperature.

Absolute Maximum Ratings ⁽¹⁾T_{amb.} = +25°C

Symbol	Parameter	Values	Unit
V _d	Drain bias voltage	7V	V
I _{dq}	Drain bias current	190	mA
V _{g1}	Gate bias voltage V _{g1}	-2 to 1	V
V _{g2}	Gate bias voltage V _{g2}	-2 to 2	V
P _{in}	Maximum CW input power overdrive	15	dBm
T _a	Operating temperature range (chip backside)	-40 to 85	°C
T _{stg}	Storage temperature range	-55 to +150	°C

⁽¹⁾ Operation of this device above anyone of these parameters may cause permanent damage: these maximum ratings parameters could not be cumulated.

These are stress ratings only, and functional operation of the device at these conditions is not implied.

Device thermal performance

All the figures given in this section are obtained assuming that the QFN device is cooled down only by conduction through the package thermal pad (no convection mode considered). The temperature is monitored at the package back-side interface (Tcase) as shown below. The system maximum temperature must be adjusted in order to guarantee that Tcase remains below the maximum value specified in the next table. So, the system PCB must be designed to comply with this requirement.

A derating must be applied on the dissipated power if the Tcase temperature cannot be maintained below the maximum temperature specified (see the curve Pdiss. Max) in order to guarantee the nominal device life time (MTTF).

The provided thermal information in the next chart is for nominal biasing point: Idq=100mA and Vd=5V, without RF drive.

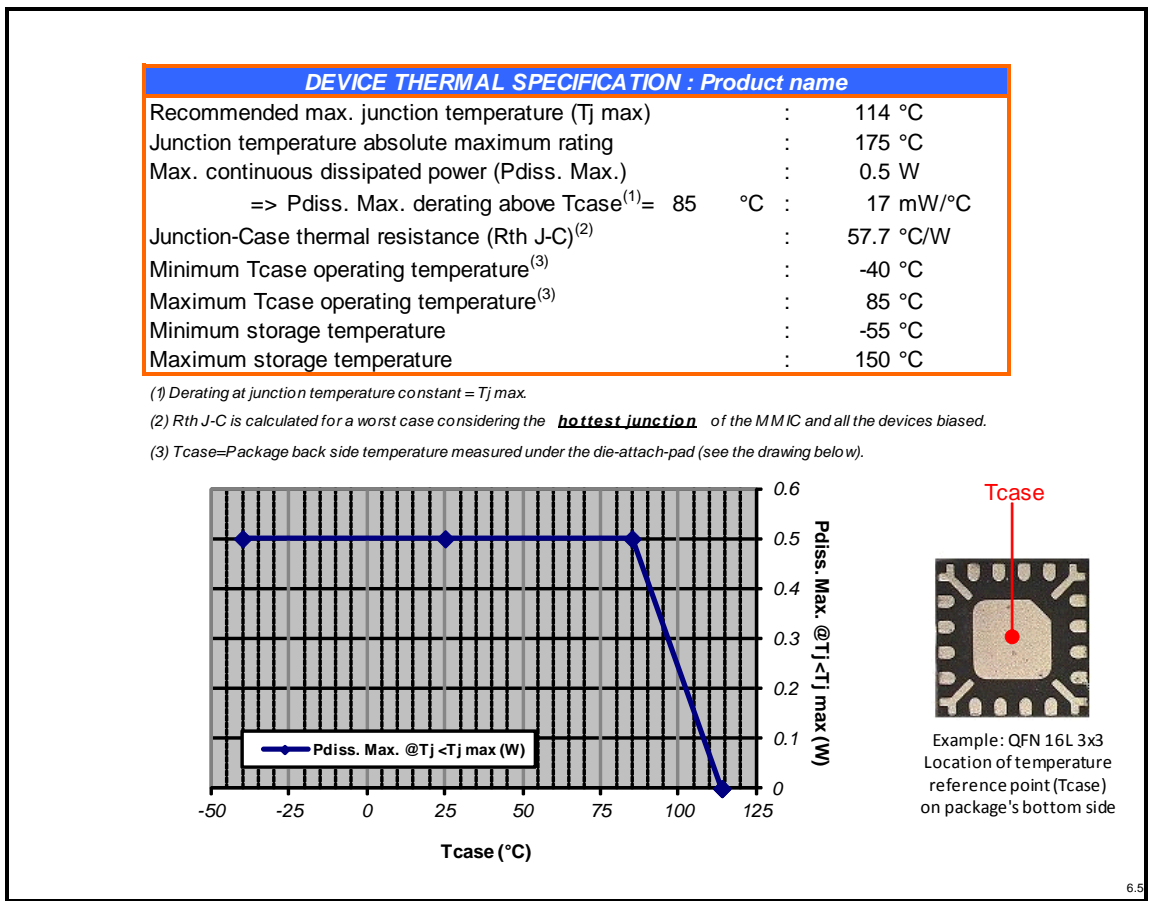

Under RF drive, for Tcase=+85°C, with Vd=5V, Id=140mA, Pout=21.6 dBm , Pdiss=0.57W then Tj max=117 °C.

Typical Board Measurements

Tamb.= +25°C, Vd=5V, Vg1 set in order to get Idq =100mA, Vg2=1.7V

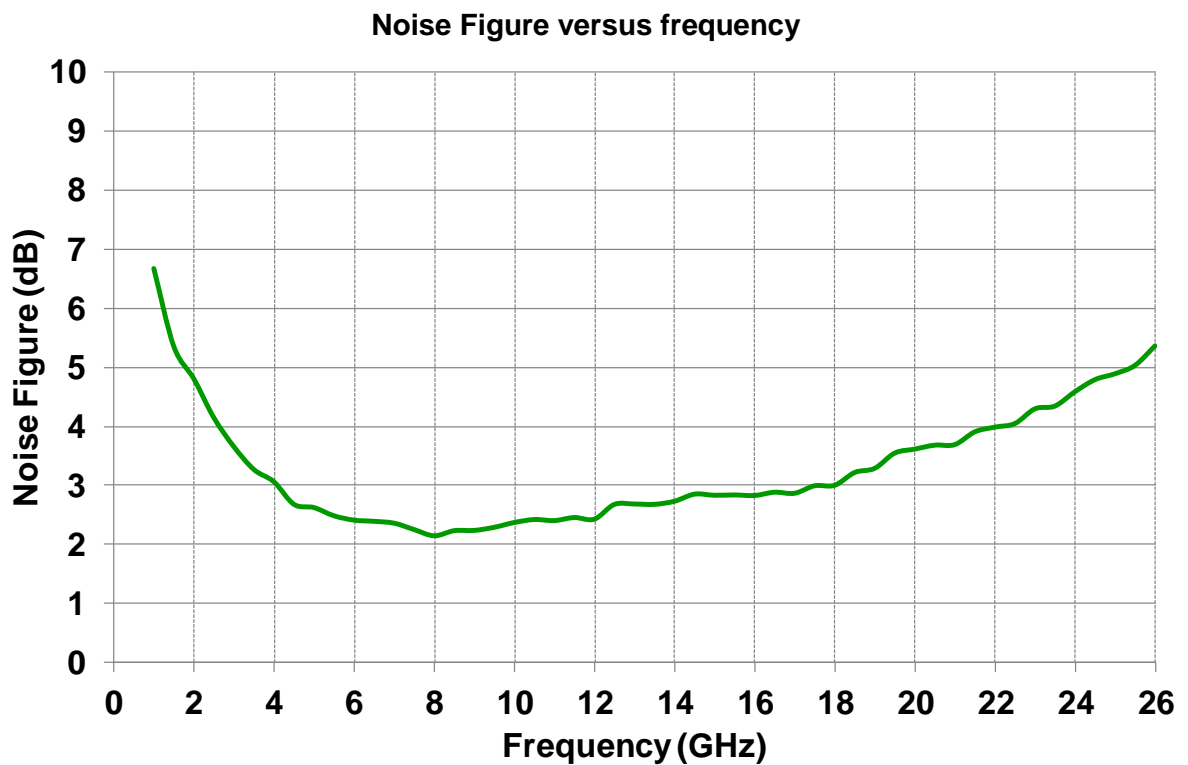
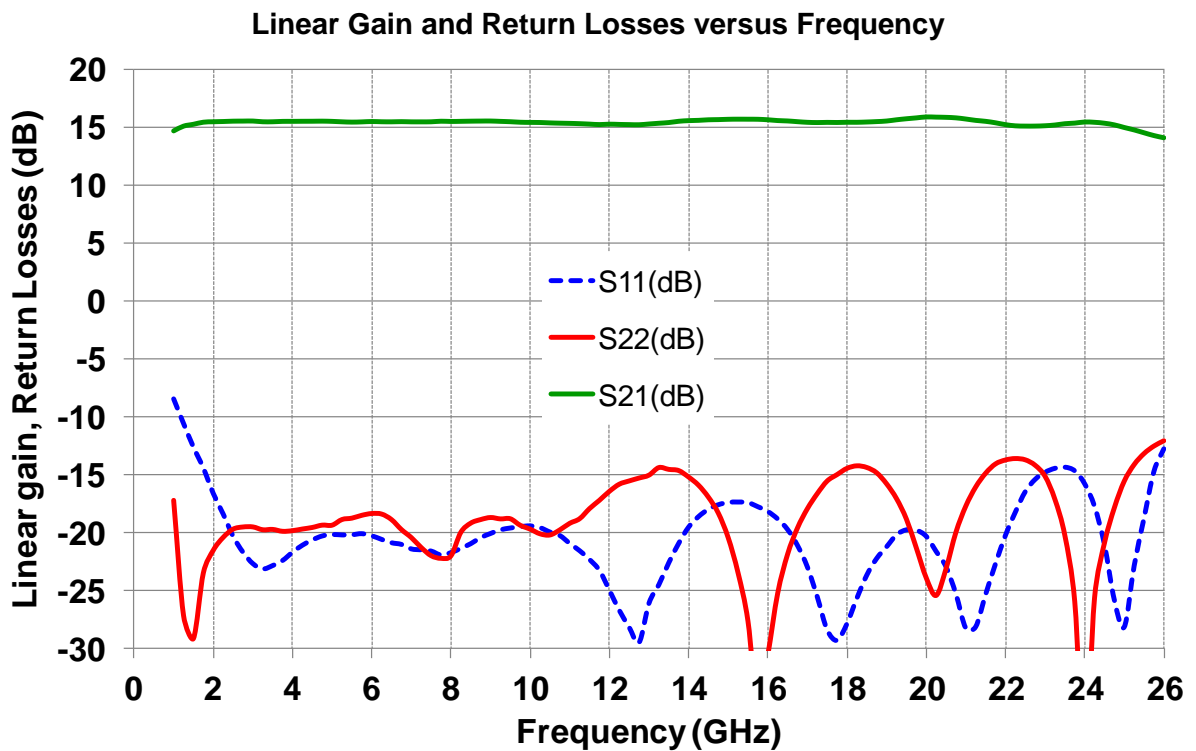

Typical Board Measurements

Tamb.= +25°C, Vd =5V, Vg1 set in order to get Idq =100mA, Vg2=1.7V

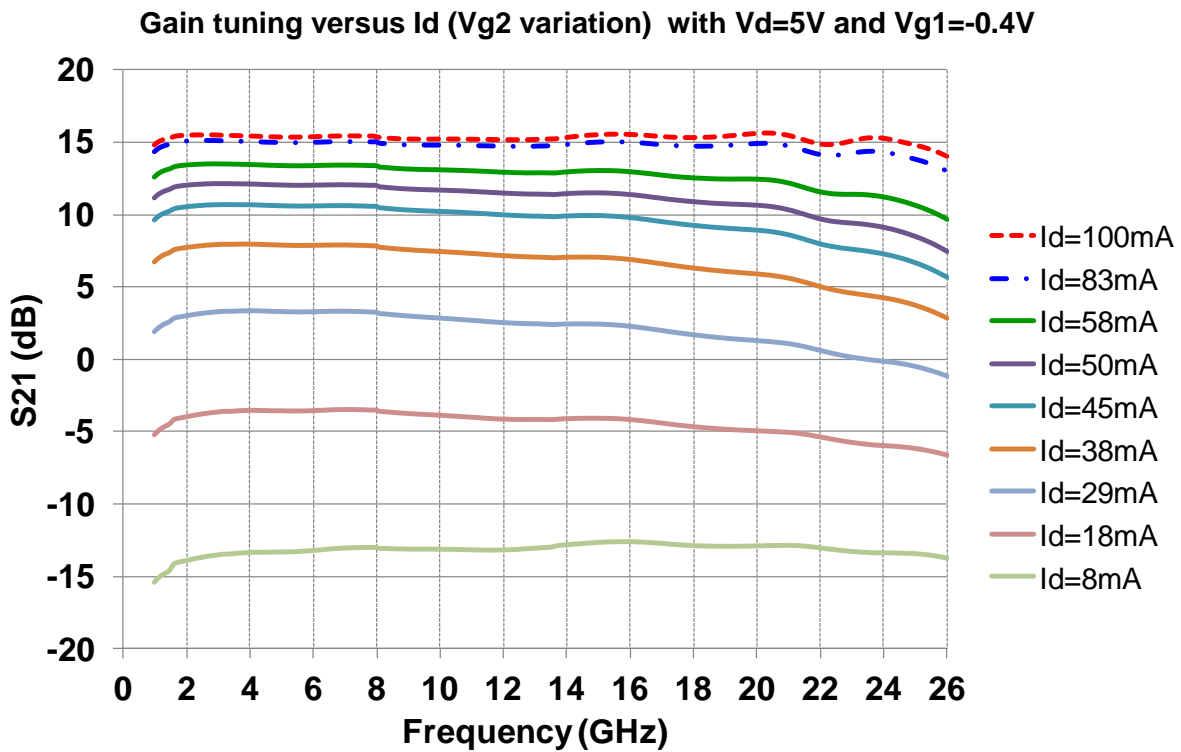
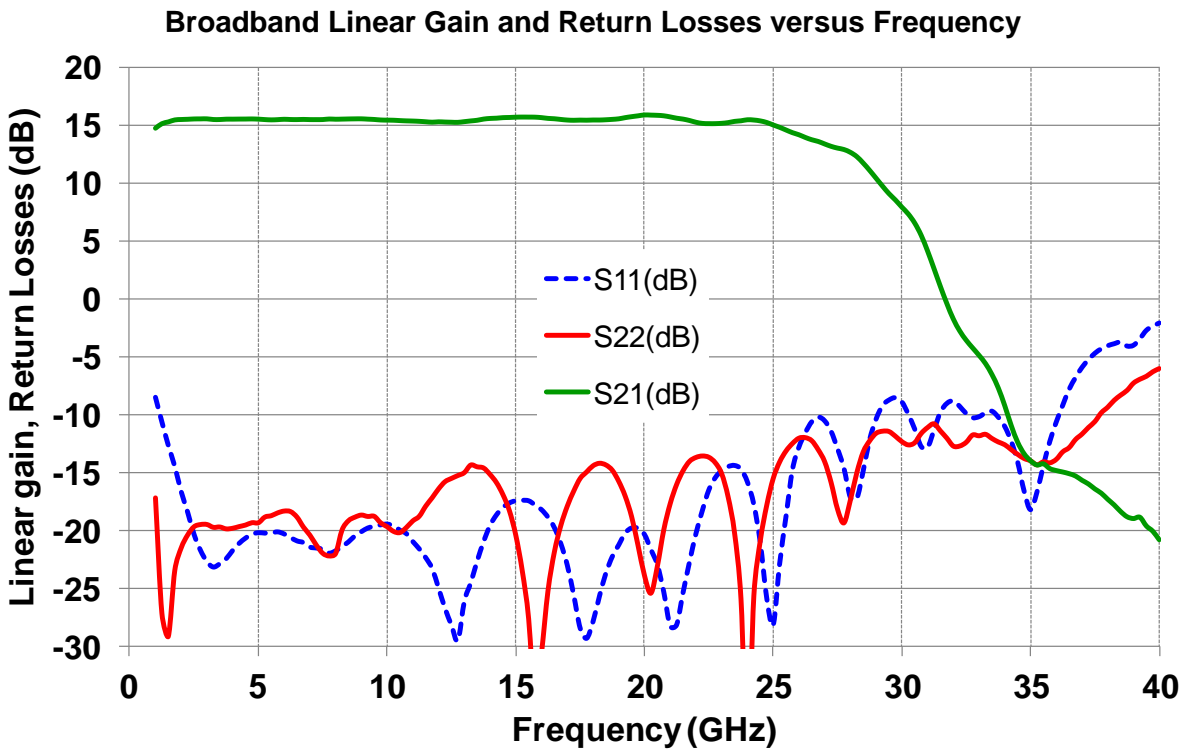

Typical Board Measurements

Tamb.= +25°C, +85°C,-40°C, Vd =5V, Vg1 set in order to get Idq =100mA, Vg2=1.7V
 Vg1 and Vg2 remain constant versus temperature.

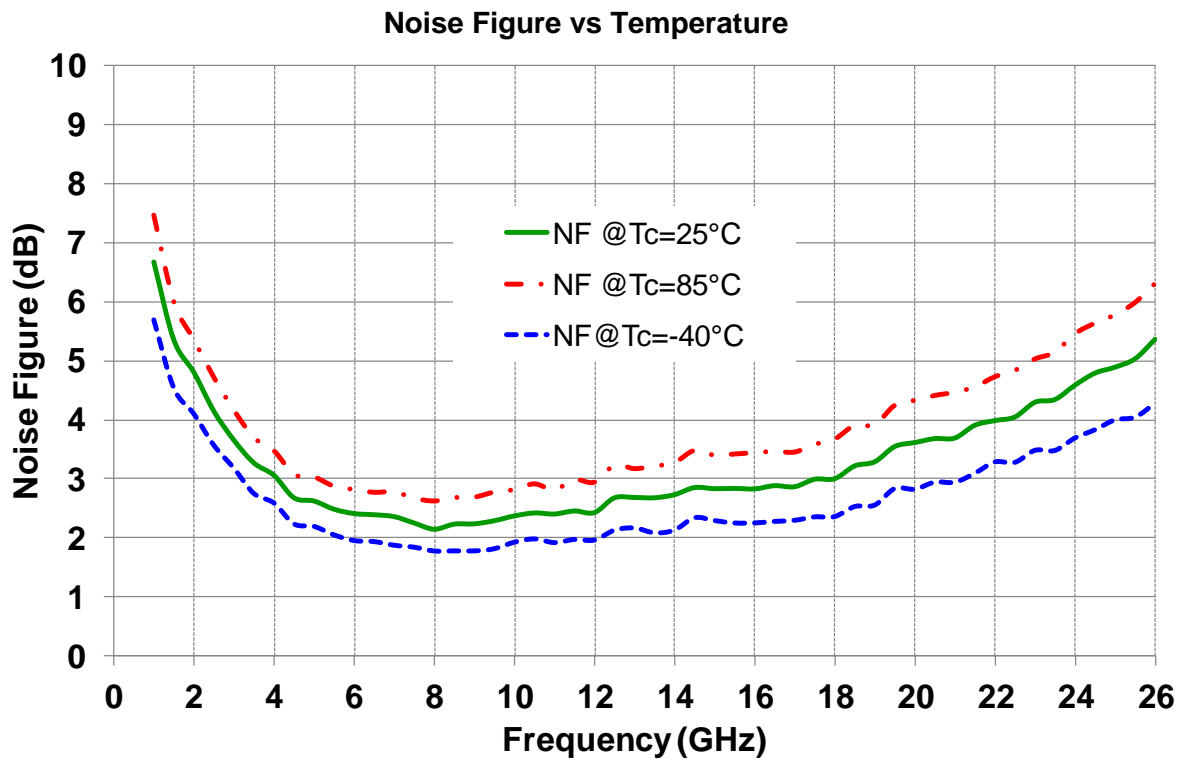
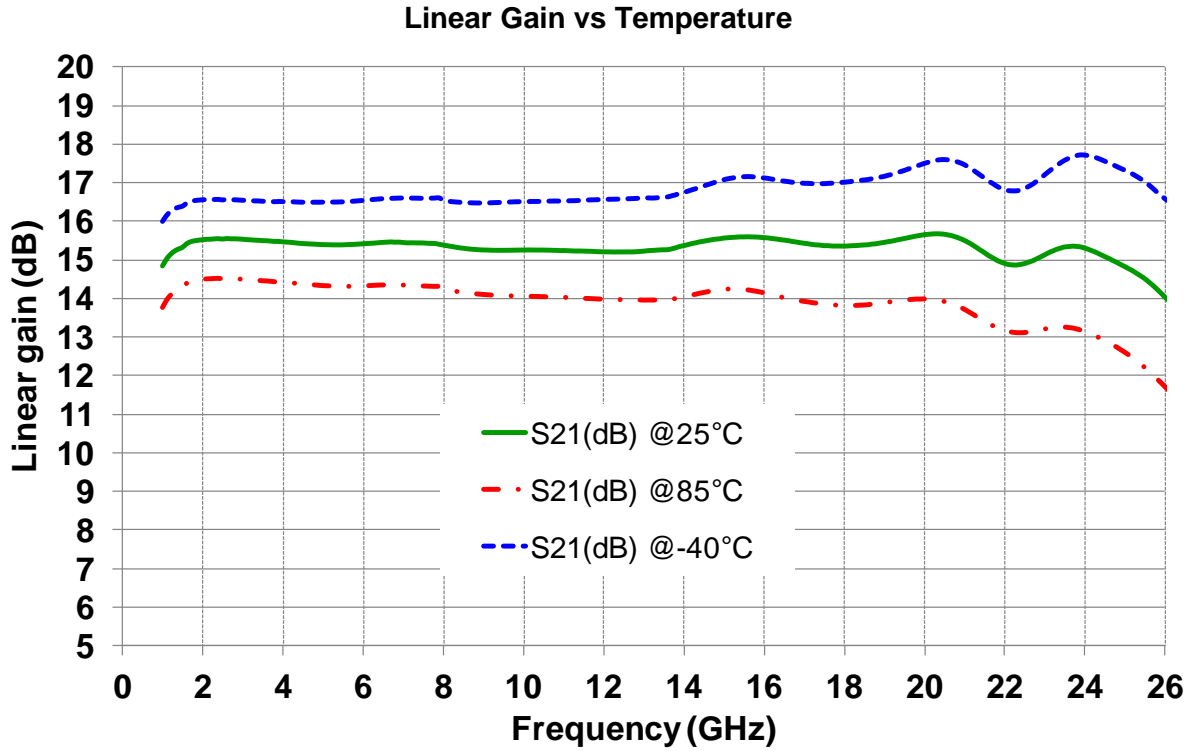

Typical Board Measurements

Tamb.= +25°C, Vd =5V, Vg1 set in order to get Idq =100/125 mA , Vg2=1.7V

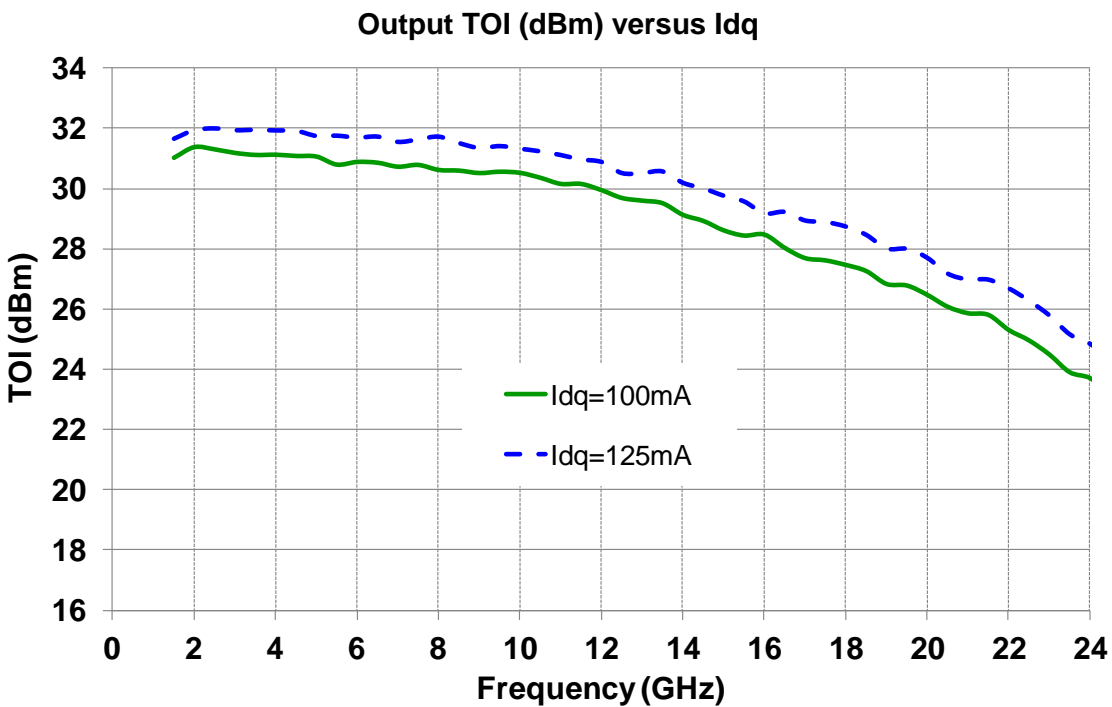
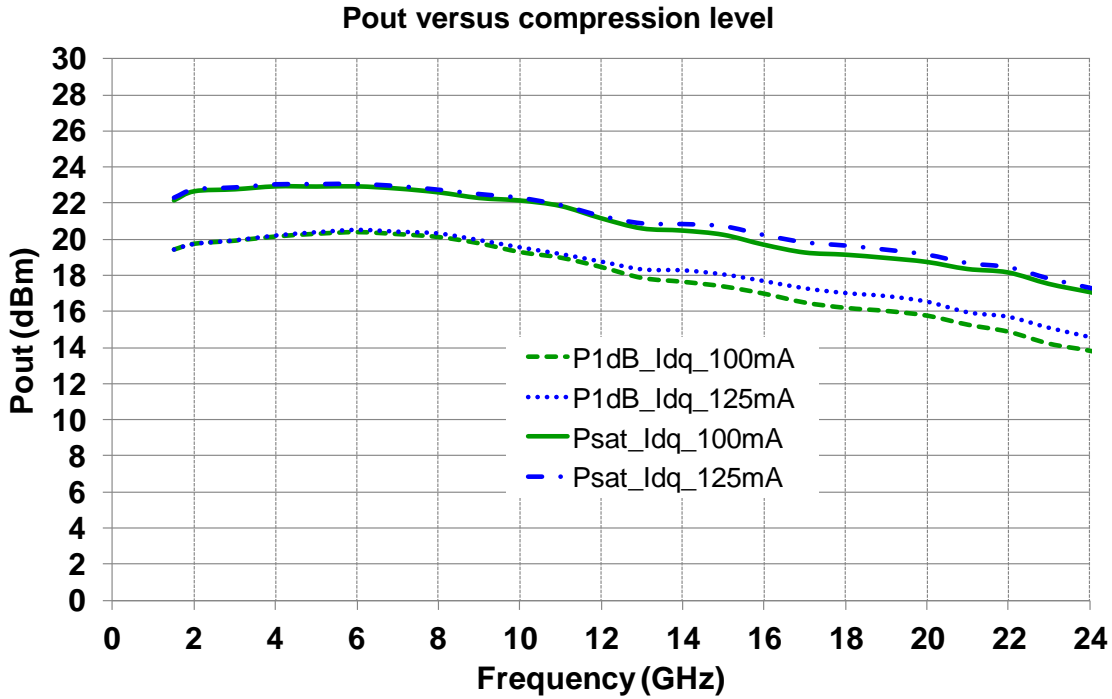

Typical Board Measurements

Tamb.= +25°C, Vd =5V, Vg1 set in order to get Idq =100mA, Vg2=1.7V

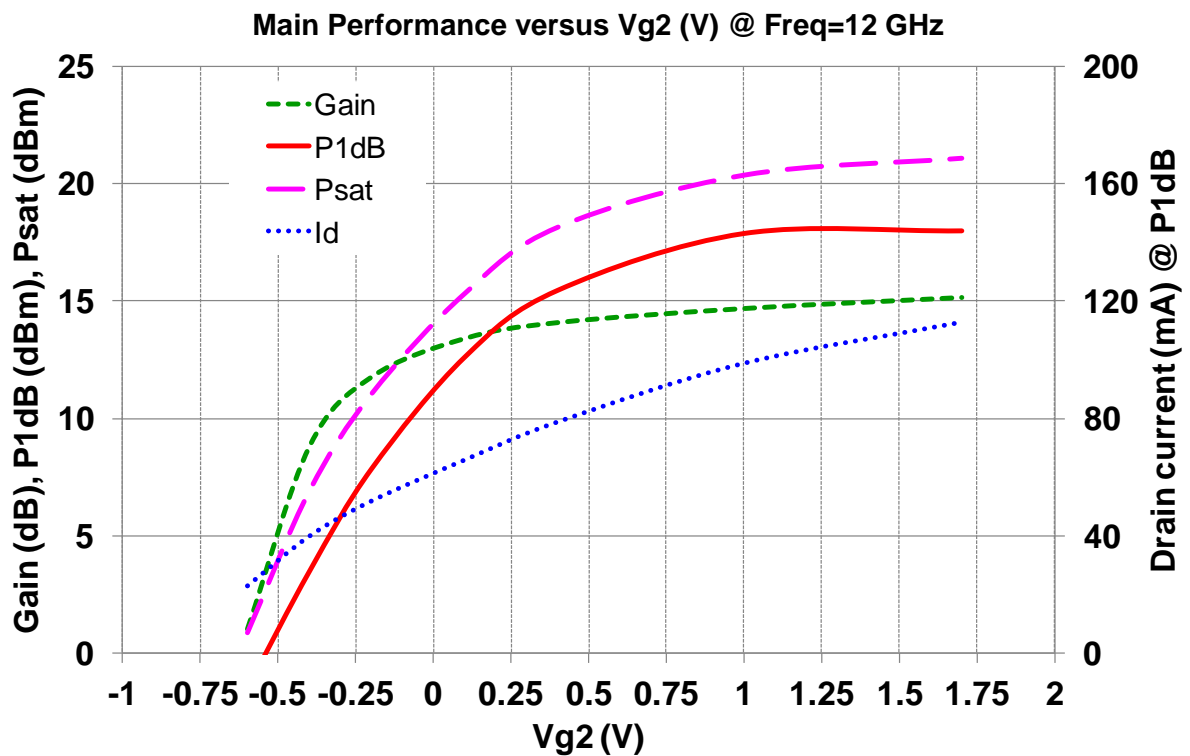
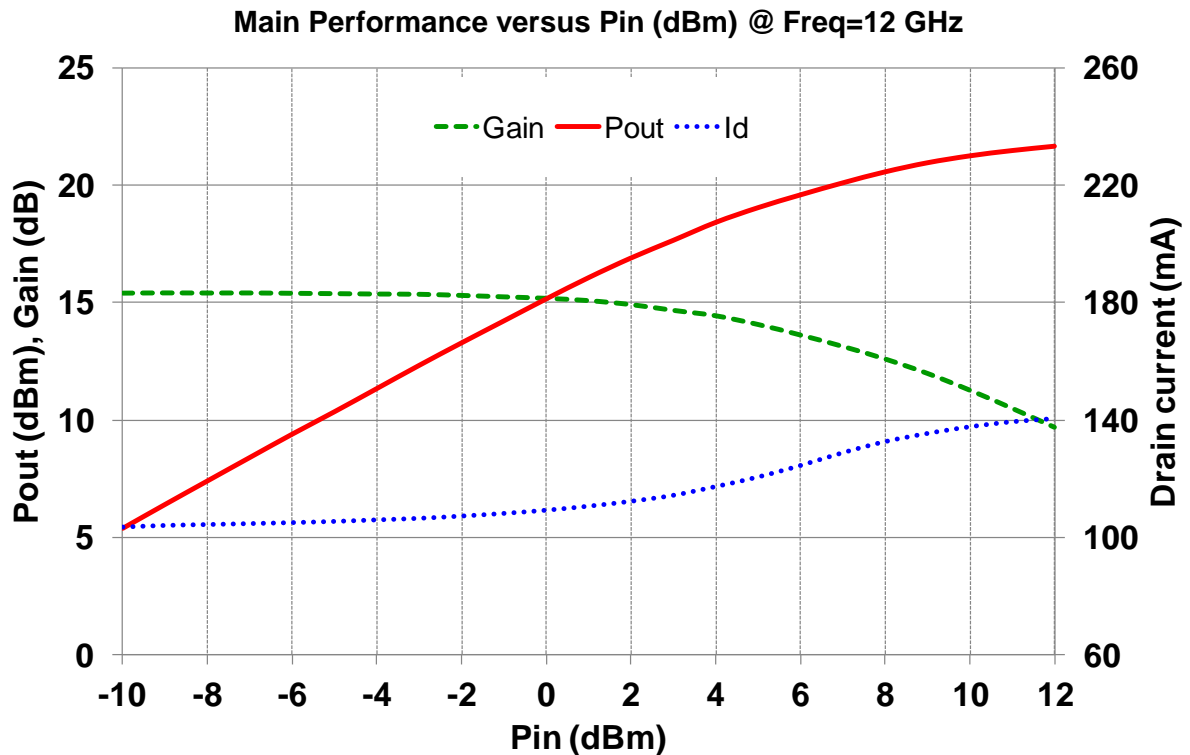

Package outline: 28 Leads 5x5 QFN ⁽¹⁾

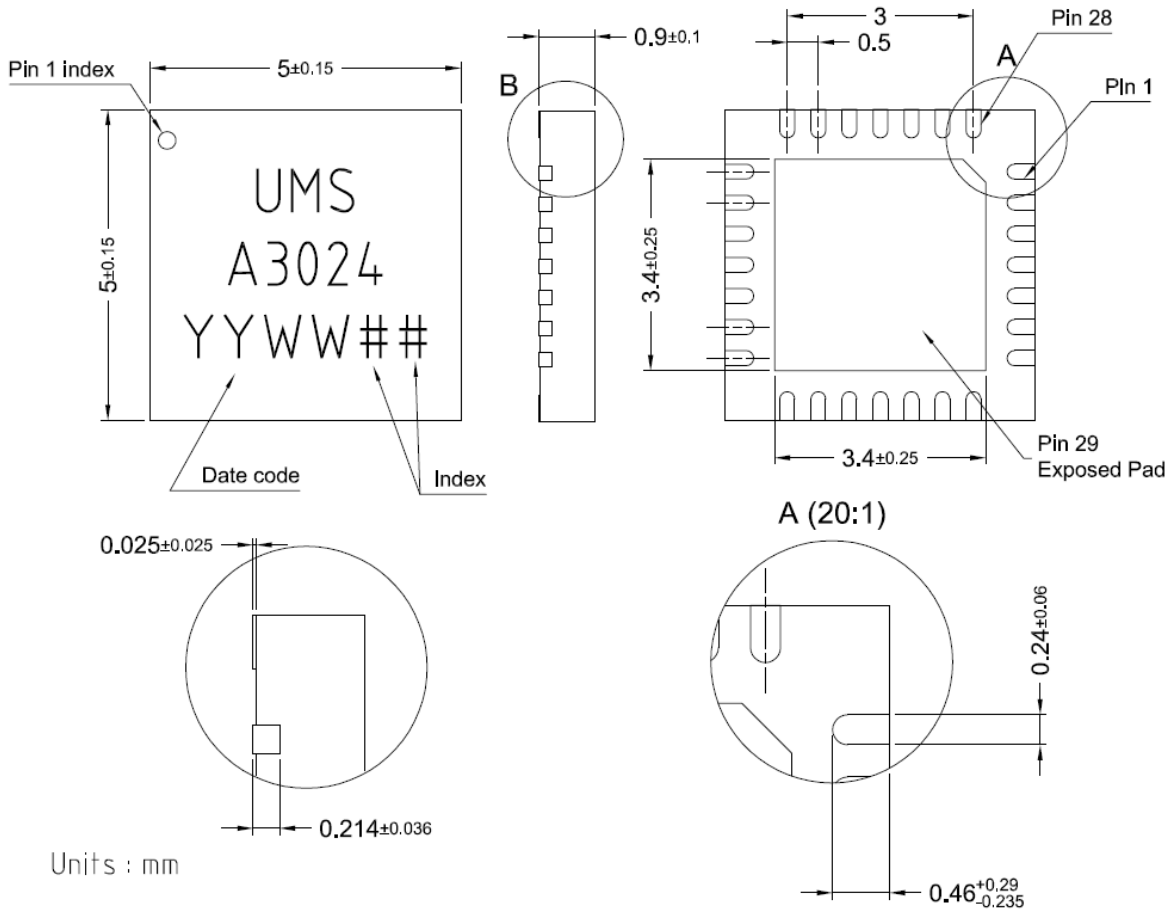

Matte tin, Lead Free (Green)	1- VG2	11- Nc	21- Nc
Units : mm	2- Nc	12- Nc	22- Nc
From the standard : JEDEC MO-220 (VHHD)	3- Nc	13- VG1	23- Nc
	4- RF in	14- Nc	24- Nc
29- GND	5- GND ⁽²⁾	15- Nc	25- VD
	6- Nc	16- Nc	26- Nc
	7- Nc	17- Nc	27- Nc
	8- Nc	18- GND ⁽²⁾	28- Nc
	9- Nc	19- RF out	
	10- Nc	20- Nc	

⁽¹⁾ The package outline drawing included to this data-sheet is given for indication. Refer to the application note AN0017 (<http://www.ums-gaas.com>) for exact package dimensions.

⁽²⁾ It is strongly recommended to ground all pins marked "Gnd" through the PCB board. Ensure that the PCB board is designed to provide the best possible ground to the package.

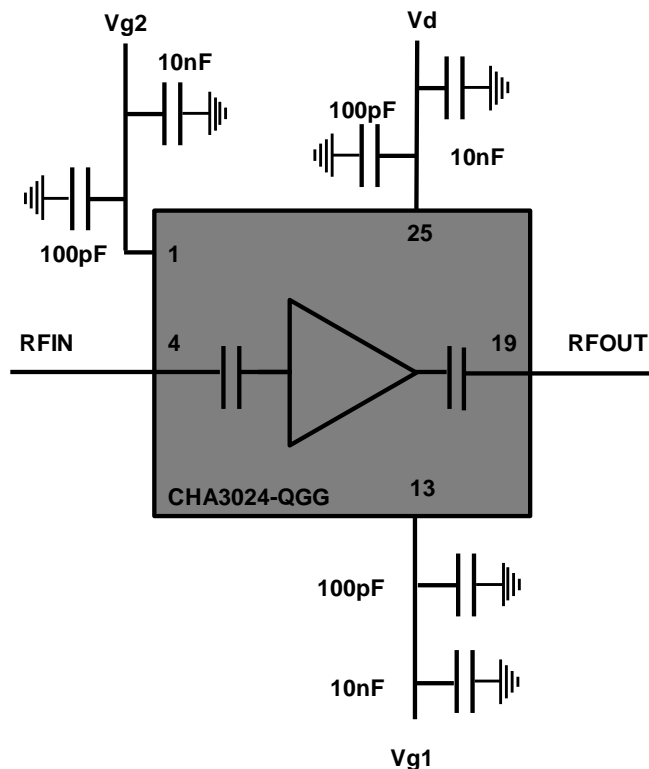
Application Circuit:

Depending on the board, additional capacitors such as 1 μ F may be added on each biasing access if necessary, for better low frequency decoupling.

Pin Description:

Pin	Symbol	Description
5,18, 29 (exposed PAD)	GND	Must be grounded properly, internal connections to ground are made
2,3,6,7,8,9,10,11,12,14,15,16,17,20,21,22,23,24,26,27,28	NC	No internal connections
4	RF IN	RF input
13	VG1	Gate voltage, bias network required
19	RF OUT	RF output
25	VD	Drain voltage, bias network required
1	VG2	Gate voltage bias network required

UMS recommends also to ground Pin 2,3,5,6,7,15,16,17,18,20,21 (see proposed footprint p14).

Proposed Evaluation Board

Compatible with the proposed footprint on page p14.

Top dielectric material is Rogers 4003 / 8mils or equivalent substrate.

Decoupling capacitors at first level are 100pF.

Decoupling capacitors at second level are 10nF.

Additional capacitors such as 1µF may also be added on each DC access.

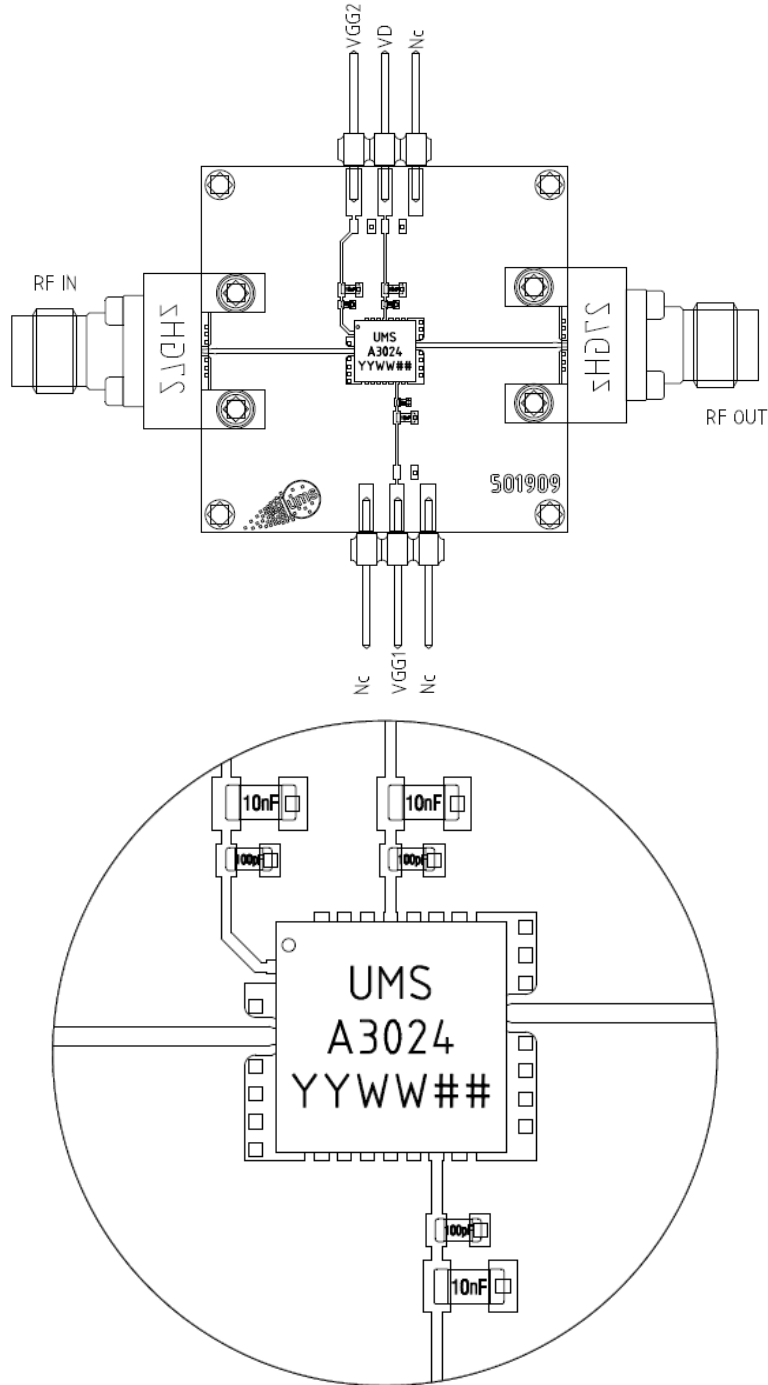

Device Operation

Device Power Up instructions:

- 1) Ground the device.
- 2) Set Vg1 to -1.5V.
- 3) Set Vd to 5V (nominal value for Vd).
- 4) Set Vg2 to 1.7V (nominal value for Vg2).
- 5) Set Vg1 in the range of -0.3V for having Idq=100mA.
- 6) Apply RF input power and adjust Vg2 to obtain desired gain.

Device Power Down instructions:

- 1) Set Vg2 to 1.7V.
- 2) Turn RF power supply off.
- 3) Set Vg1 to -1.5V in order to get Idq=0mA.
- 4) Set Vg2 to 0V.
- 5) Set Vd to 0V.
- 6) Set Vg1 to 0V.

DC Schematic

Vd=5V, Vg1=-0.3V, Vg2=1.7V, Idq=100mA

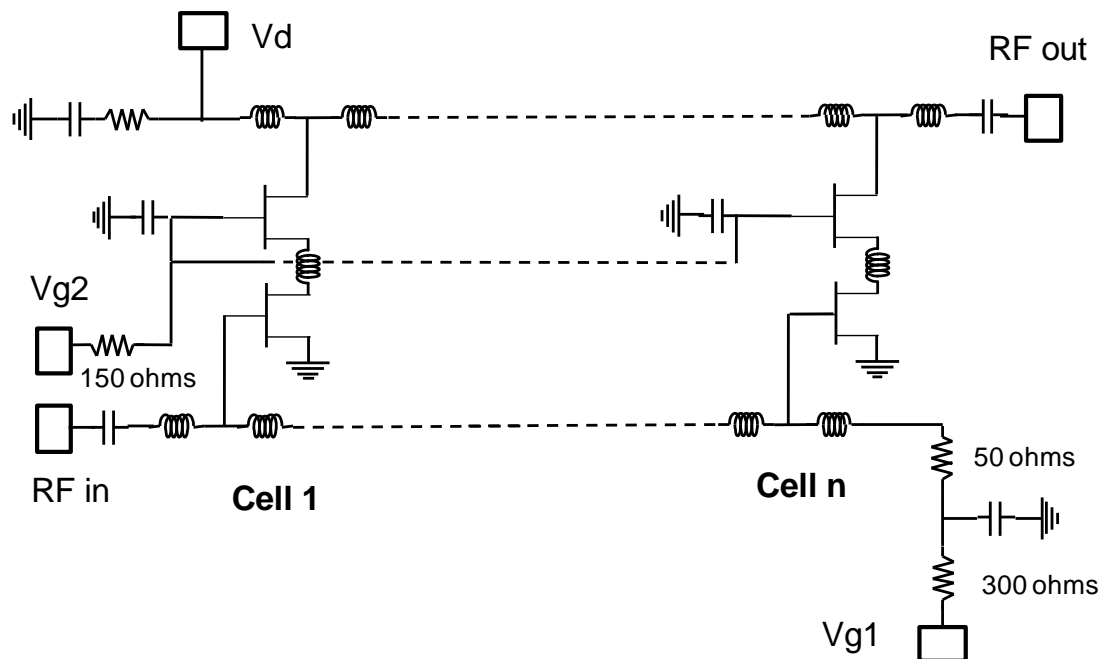

Package footprint and Definition of the measurements planes

The reference planes used for the provided measurements are symmetrical from the symmetrical axis of the package (see drawing beside). The input and output reference planes are located at 3.65 mm offset (input wise and output wise respectively) from this axis.
 From the edge of the QFN, the reference planes are 1.15mm apart.

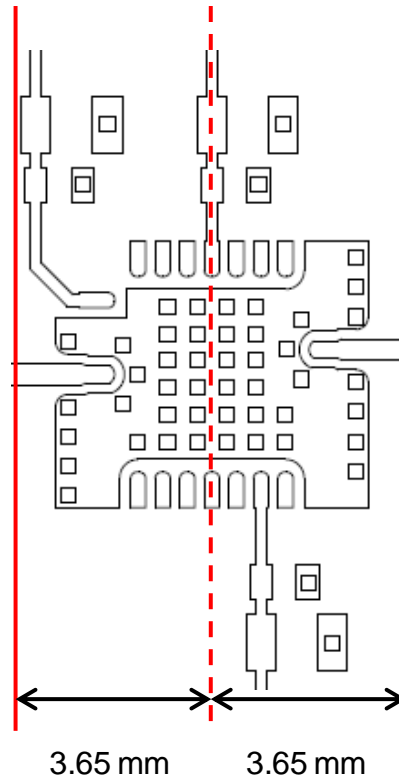

Package Information

Parameter	Value
Package body material	RoHS-compliant
	Low stress Injection Molded Plastic
Lead finish	100% matte tin (Sn)
MSL Rating	MSL3

Note



Recommended package footprint

Refer to the application note AN0017 available at <http://www.ums-gaas.com> for package footprint recommendations.

SMD mounting procedure

For the mounting process standard techniques involving solder paste and a suitable reflow process can be used. For further details, see application note AN0017.

Recommended environmental management

UMS products are compliant with the regulation in particular with the directives RoHS N°2011/65 and REACH N°1907/2006. More environmental data are available in the application note AN0019 also available at <http://www.ums-gaas.com>.

Recommended ESD management

Refer to the application note AN0020 available at <http://www.ums-gaas.com> for ESD sensitivity and handling recommendations for the UMS package products.

Ordering Information

QFN 28L 5x5 package:

CHA3024-QGG/XY

Stick: XY = 20

Tape & reel: XY = 21

Information furnished is believed to be accurate and reliable. However **United Monolithic Semiconductors S.A.S.** assumes no responsibility for the consequences of use of such information nor for any infringement of patents or other rights of third parties which may result from its use. No license is granted by implication or otherwise under any patent or patent rights of **United Monolithic Semiconductors S.A.S.** Specifications mentioned in this publication are subject to change without notice. This publication supersedes and replaces all information previously supplied. **United Monolithic Semiconductors S.A.S.** products are not authorised for use as critical components in life support devices or systems without express written approval from **United Monolithic Semiconductors S.A.S.**