

▪ **Outline Dimension Drawing**

Dimensions: mm[inch]

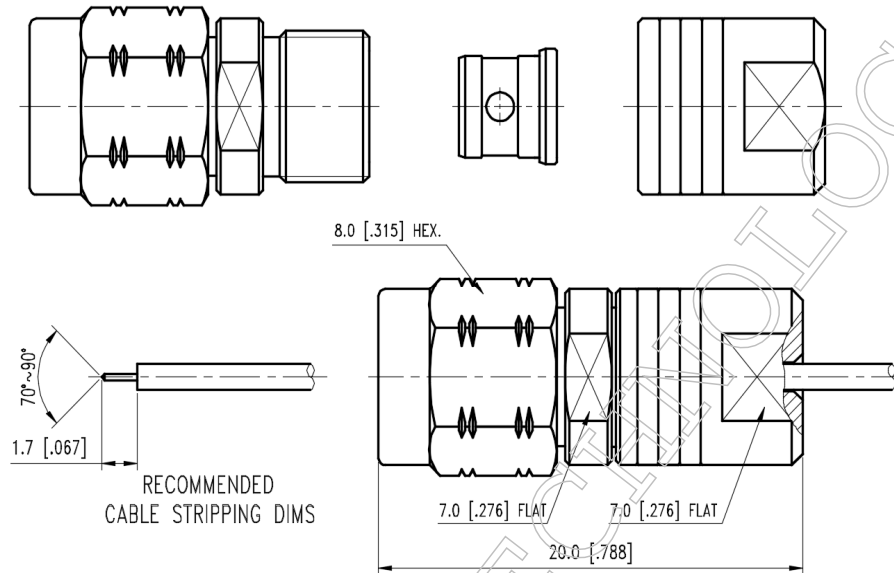

▪ **Material Specification**

Description	Material	Plating
Body*3	Stainless steel	Passivate
Contact*2	BeCu	Gold
Dielectric	High performance application material	
Clamp	Brass	Gold
Ring	Stainless steel	
Coupling nut	Stainless steel	Gold

In the effort to improve our products, we reserve the right to make changes judged to be necessary



▪ **Electrical Specification**

Description		Description	
Impedance	50 Ω	Insulation Resistance	5000 MΩ Min.
Frequency	40 GHz	Inner Contact Resistance	3 mΩ Max.
VSWR	1.2 Max.	Outer Contact Resistance	2 mΩ Max.
Insertion Loss	0.4 dB Max.		
Voltage Rating	170 Vrms Max.		
Dielectric Withstanding Voltage	375 Vrms Max.		

▪ **Mechanical Specification**

Description		Description	
Center Contact		Recommended Torque	7~9 in. lbs
Axial Force-Mating End	6 lbs.	Coupling Test Torque	15.0 in. lbs
Axial Force-Opposite End	6 lbs.		
Connector Durability	500 cycles		
Weight	N/A g		

▪ **Environmental Specification**

Description	
Temperature Min.	-45 °C
Temperature Max.	105 °C
Hermetic Seal	N/A

In the effort to improve our products, we reserve the right to make changes judged to be necessary