



112WMT WR112 Waveguide Magic Tee 7.05-10GHz with Four Rectangular Waveguide Interfaces

WR112 Waveguide Magic Tee Operating From 7.05 to 10GHz with Four Rectangular Waveguide Interfaces

### Product Information

SKU	112WMT
-----	--------

### Description

Waveguide magic tee 112WMT, operating from 7.05 to 10GHz with a 0.4dB insertion loss, a 40dB isolation, H-Plane VSWR 1.30:1 and E-Plane VSWR 1.50:1. 112WMT is a four-ports hybrid coupler or power divider. All the ports have standard WR112 waveguides with the same flanges FBP84(UBR84). The magic tee can be used as a power combiner or a power divider based on the given application's needs.

### Technical Specification

Electrical Specification	
WG Tee Type	Magic Tee
Waveguide Band	C X
Waveguide Type	Rectangular
Waveguide Size EIA WR	WR112
Frequency, Min (GHz)	7.05
Frequency, Max (GHz)	10
I.L., Typ (dB)	0.4
I.L., Max (dB)	0.6
VSWR, H-Plane, Typ	1.3
VSWR, H-Plane, Typ	1.30:1
VSWR, E-Plane, Typ	1.5
VSWR, E-Plane, Typ	1.50:1
Isolation, Min (dB)	30
Isolation, Typ (dB)	40
Amplitude Balance, Max ( $\pm$ dB)	0.4
Power Handling, CW, (W)	660
Power Handling, Peak, (KW)	360
Interface	
Flange 1 Style	Square
Flange 1 Type	Cover
Flange 1 Designation	FBP84(UBR84)
Flange 2 Style	Square
Flange 2 Type	Cover
Flange 2 Designation	FBP84(UBR84)

Interface	
Flange 3 Style	Square
Flange 3 Type	Cover
Flange 3 Designation	FBP84(UBR84)
Flange 4 Style	Square
Flange 4 Type	Cover
Flange 4 Designation	FBP84(UBR84)
Mechanical Specification	
Body Material	Al
Size, L (mm)	82.6
Size, W (mm)	65.2
Size, H (mm)	65.2
Weight, (kg)	0.34
Pressure Sealed	No
Environmental Specification	
Operating Temp. Low ( $^{\circ}$ C)	-55
Operating Temp. High ( $^{\circ}$ C)	85
Storage Temp. Low ( $^{\circ}$ C)	-60
Storage Temp. High ( $^{\circ}$ C)	90

### Additional Information

Application	General Purpose Indoor & Outdoor, Fixed
-------------	---

Outline Drawing(Size: mm)

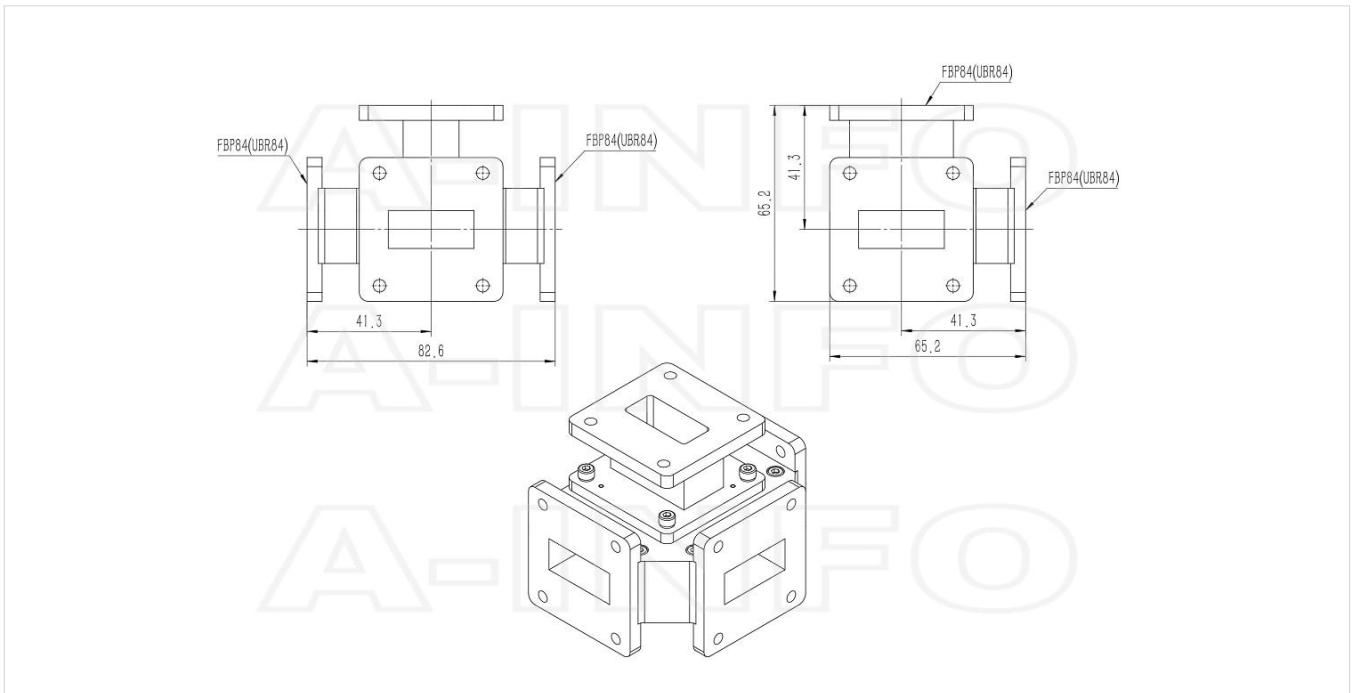

## Flange Drawing(Size: mm)

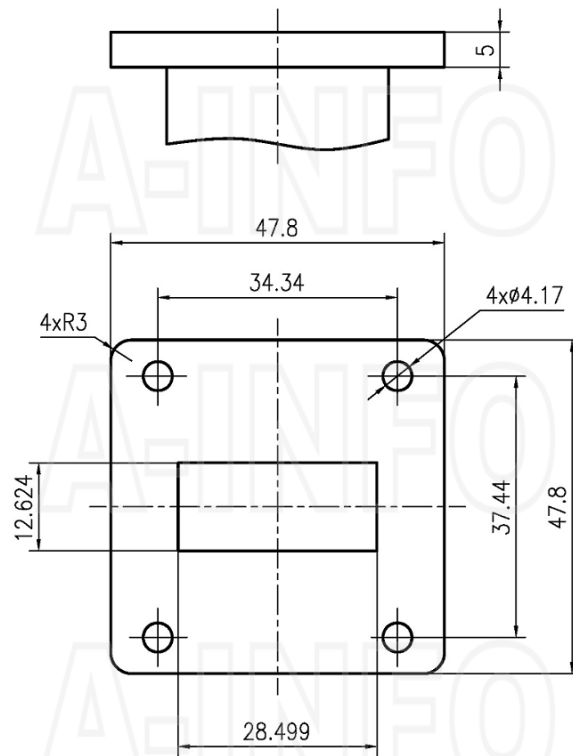

**FBP84**

## Typical Test Results

### VSWR

#### H-Plane

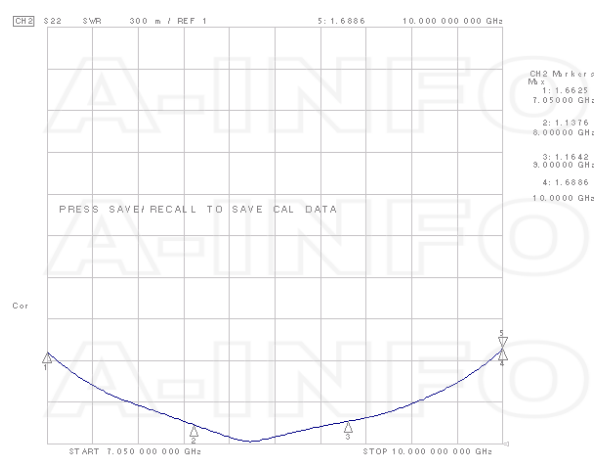

### E-Plane

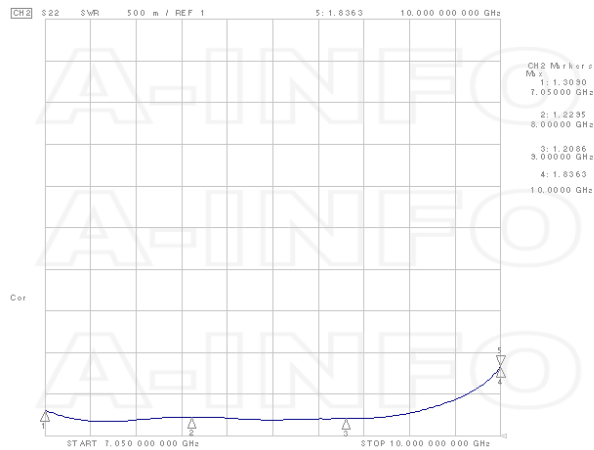

### Unbalance

#### H-Plane

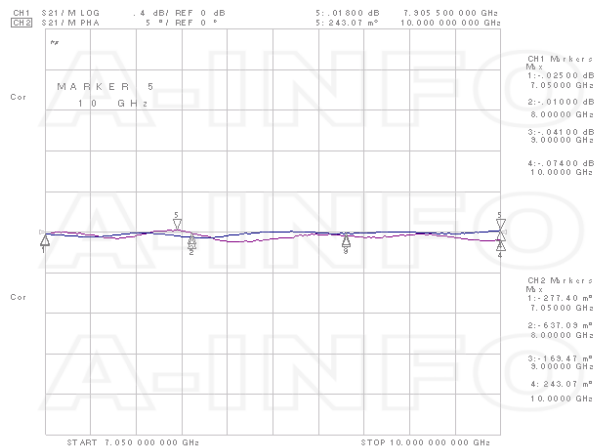

#### E-Plane

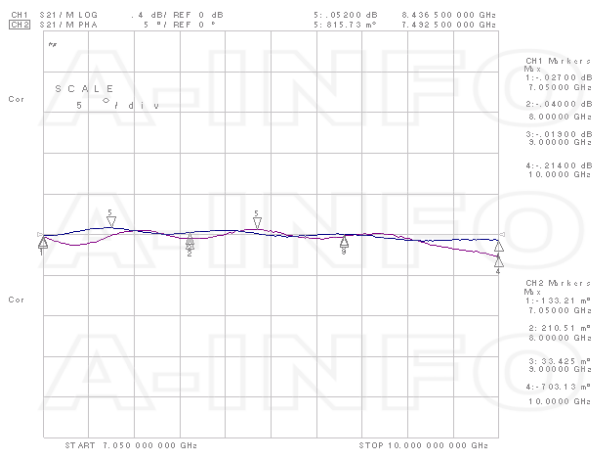

### Isolation

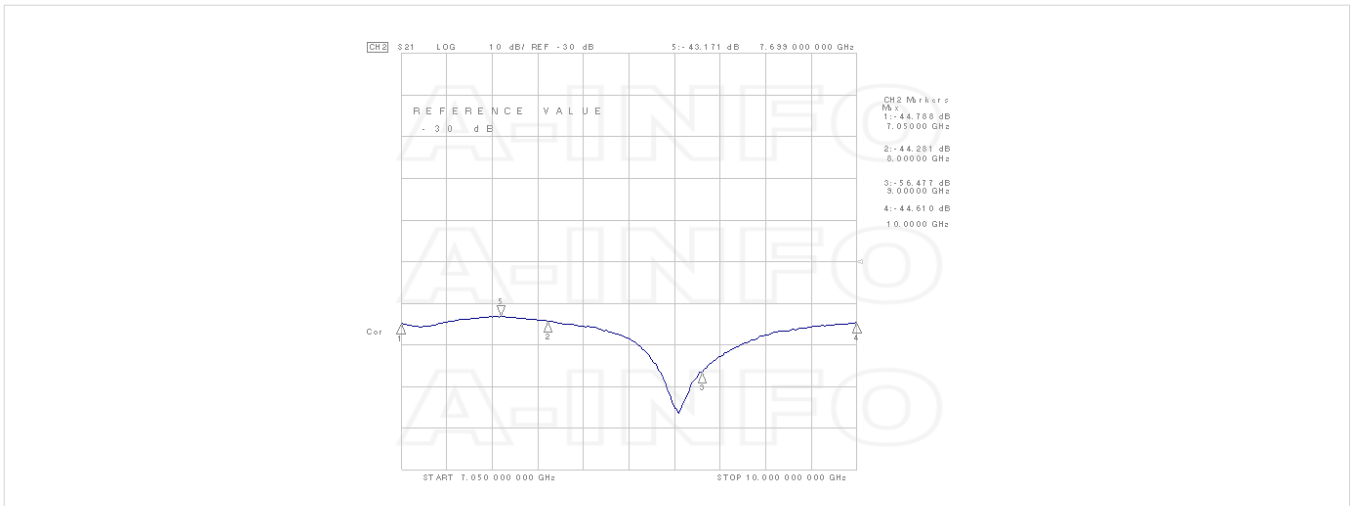

### Similar Products



112WET WR112 Waveguide E-Plane Tee 7.05-10GHz with Three Rectangular Waveguide Interfaces



112WHT WR112 Waveguide H-Plane Tee 7.05-10GHz with Three Rectangular Waveguide Interfaces



137WET WR137 Waveguide E-Plane Tee 5.85-8.2GHz with Three Rectangular Waveguide Interfaces



137WHT WR137 Waveguide H-Plane Tee 5.85-8.2GHz with Three Rectangular Waveguide Interfaces



137WMT WR137 Waveguide Magic Tee 5.85-8.2GHz with Four Rectangular Waveguide Interfaces



90WET WR90 Waveguide E-Plane Tee 8.2-12.4GHz with Three Rectangular Waveguide Interfaces



90WHT WR90 Waveguide H-Plane Tee 8.2-12.4GHz with Three Rectangular Waveguide Interfaces



90WMT WR90 Waveguide Magic Tee 8.2-12.4GHz with Four Rectangular Waveguide Interfaces

### About this Datasheet

<ul style="list-style-type: none"><li>● <b>Product Information</b></li></ul> <p>Product Link: <a href="https://www.ainfoinc.com/112wmt-wr112-waveguide-magic-tee-7-05-10-ghz-fbp84-ubr84">https://www.ainfoinc.com/112wmt-wr112-waveguide-magic-tee-7-05-10-ghz-fbp84-ubr84</a> Data subject to change without notice. © A-INFO INC. 2024. All Rights Reserved</p>	<ul style="list-style-type: none"><li>● <b>Contact Us</b></li></ul> <p>Address: 60 Tesla, Irvine, CA 92618, USA</p> <p>Website: <a href="http://www.ainfoinc.com">www.ainfoinc.com</a></p> <p>Email: <a href="mailto:sales@ainfoinc.com">sales@ainfoinc.com</a></p>	<ul style="list-style-type: none"><li>● <b>Phone &amp; Fax</b></li></ul> <p>Phone: +1-949-639-9688 +1-949-639-9608</p> <p>Fax: +1-949-639-9670</p>
--	---	--