

X-Band 6-Bit Digital Phase Shifter

GaAs Monolithic Microwave IC

Description

CHP3015-99F is an X-Band (8.5-11.5GHz) monolithic 6-bit digital phase-shifter with a 0-360° range and high phase accuracy. The average RMS phase error is 2.5°. The circuit provides 7.5dB insertion loss associated with input and output return losses better than 13dB under all states. An on-chip DC-interface is compatible with both CMOS (0/+3.3V) and TTL (0/+5V) logics.

The circuit is mainly dedicated to defense and space systems and is also well suited for a wide range of microwave applications. The MMIC is developed on a robust 0.25µm gate length pHEMT process.

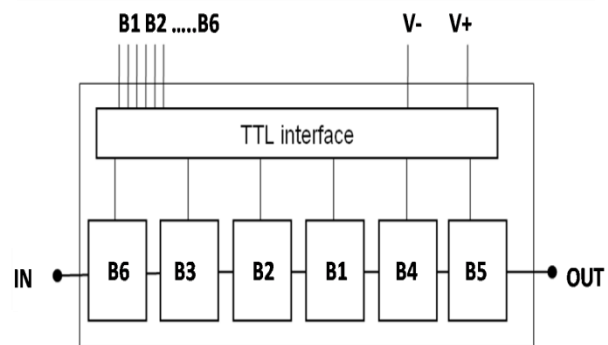

Main Features

- 2.5 deg average RMS phase error
- Low I/O return losses (all states)
- 24dBm Input P1dB
- CMOS/TTL compatibility: V+ = +3.3/5V
- DC-decoupled I/O
- Chip size 2.41x2.41x0.1mm

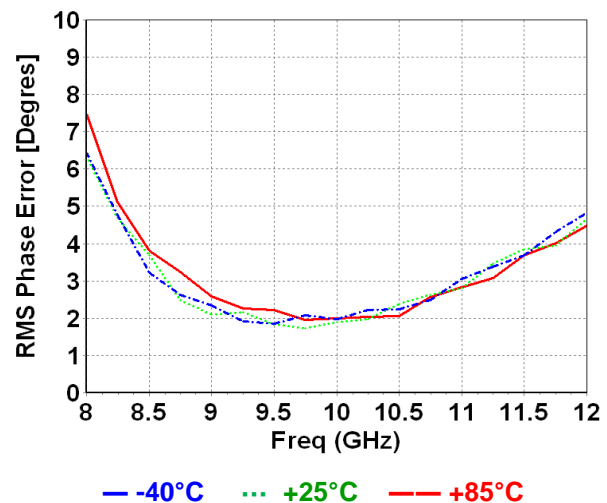

Main Characteristics

Tamb.= +25°C

Symbol	Parameter	Min	Typ	Max	Unit
Freq	Frequency range	8.5		11.5	GHz
PPE	Peak Phase Error		(-3, +5)		deg
RMS_PE	RMS Phase Error		2.5		deg

Main Characteristics

Tamb.= +25°C

Symbol	Parameter	Min	Typ	Max	Unit
Fop	Operating frequency range	8.5		11.5	GHz
PhS	Phase Shifting Range	0		360	deg
PhS step	Phase Shifting Step		5.625		deg
PPE	Peak Phase Error		(-3, +5)		deg
RMS_PE	RMS Phase Error		2.5		deg
IL	Insertion Loss		7.5		dB
Av	Amplitude Variation		(-0.5, +1)		dB
RMS_Av	RMS Amplitude Variation		0.4		dB
VSWR_In	Input Return Loss		14		dB
VSWR_Out	Output Return Loss		13		dB
P1dB	Input power @ 1dBcomp		24		dBm
OP1dB	Output power @ 1dBcomp		15.5		dBm
Vlow	Control Voltage – low level	0		0.4	V
Vhigh	Control Voltage – high level	2.4		6	V
V+	Positive Supply Voltage		5 or 3.3		V
V-	Negative Supply Voltage		-5		V
I+	Positive Supply Current		4		mA
I-	Negative Supply Current		3.5		mA
tR	Rise time			10	ns
tF	Fall time			10	ns
ton	On time			25	ns
toff	Off time			25	ns
Top	Operating temperature	-40		+85	deg

These values are representative of the chip's typical performances with two parallel and one single bonding wire respectively at the input and output RF ports, each approximately 400um long.

Peak Phase Error (PPE) definition

$PPE(i) = \text{measured_Phase}(S21)@state(i) - \text{measured_Phase}(S21)@state(0) - \text{theoreticalPhaseValue}@State(i)$

Amplitude Variation (Av) definition

$Av(i) = \text{Measured_dB}(S21)@state(i) - \text{Measured_dB}(S21)@state(0)$

RMS Phase Error (RMS_PE) definition

$$RMS_PE = \sqrt{\frac{\sum_{i=0}^{63} PPE^2(i)}{64}}$$

where i is the state number (from 0 to 63)

RMS Amplitude variation (RMS_Av) definition

$$RMS_AV = Av = \frac{\sum_{i=0}^{63} Av(i)}{64}$$

where i is the state number (from 0 to 63)

Absolute Maximum Ratings ⁽¹⁾

Tamb.= +25°C

Symbol	Parameter	Values	Unit
V+	Maximum DC positive supply voltage	+6	V
V-	Maximum DC negative supply voltage	-6	V
Vlow	Minimum control voltage	-2	V
Vhigh	Maximum control voltage	+6	V
Tj	Maximum junction temperature	175	°C
Ta	Operating temperature range	-40 to +85	°C
Tstg	Storage temperature range	-55 to +150	°C

⁽¹⁾ Operation of this device above anyone of these parameters may cause permanent damage.

Typical Bias Conditions

Two options are possible for the positive value of the biasing circuit without impact on the RF performances.

Option 1

Symbol	PAD #°	Parameter	Values	Unit
V+	4, 10	Positive Supply Voltage	+5	V
V-	6, 9	Negative Supply Voltage	-5	V
V+	5, 8	Positive Supply Voltage	NC	
Bit1 to Bit6	11 to 16	Control Voltage	0 / +3.3	V

Option 2

Symbol	PAD #°	Parameter	Values	Unit
V+	4, 10	Positive Supply Voltage	+3.3	V
V-	6, 9	Negative Supply Voltage	-5	V
V+	5, 8	Positive Supply Voltage	+3.3	V
Bit1 to Bit6	11 to 16	Control Voltage	0 / +3.3	V

Phase shifter control table

Voltage to apply on Bit 1 to Bit 6 (pads 11 to 16):

State	Phase (deg)	Bit 6	Bit 5	Bit 4	Bit 3	Bit 2	Bit 1	State	Phase (deg)	Bit 6	Bit 5	Bit 4	Bit 3	Bit 2	Bit 1
0	0	0	0	0	0	0	0	32	180	3.3	0	0	0	0	0
1	5.625	0	0	0	0	0	3.3	33	185.625	3.3	0	0	0	0	3.3
2	11.25	0	0	0	0	3.3	0	34	191.25	3.3	0	0	0	3.3	0
3	16.875	0	0	0	0	3.3	3.3	35	196.875	3.3	0	0	0	3.3	3.3
4	22.5	0	0	0	3.3	0	0	36	202.5	3.3	0	0	3.3	0	0
5	28.125	0	0	0	3.3	0	3.3	37	208.125	3.3	0	0	3.3	0	3.3
6	33.75	0	0	0	3.3	3.3	0	38	213.75	3.3	0	0	3.3	3.3	0
7	39.375	0	0	0	3.3	3.3	3.3	39	219.375	3.3	0	0	3.3	3.3	3.3
8	45	0	0	3.3	0	0	0	40	225	3.3	0	3.3	0	0	0
9	50.625	0	0	3.3	0	0	3.3	41	230.625	3.3	0	3.3	0	0	3.3
10	56.25	0	0	3.3	0	3.3	0	42	236.25	3.3	0	3.3	0	3.3	0
11	61.875	0	0	3.3	0	3.3	3.3	43	241.875	3.3	0	3.3	0	3.3	3.3
12	67.5	0	0	3.3	3.3	0	0	44	247.5	3.3	0	3.3	3.3	0	0
13	73.125	0	0	3.3	3.3	0	3.3	45	253.125	3.3	0	3.3	3.3	0	3.3
14	78.75	0	0	3.3	3.3	3.3	0	46	258.75	3.3	0	3.3	3.3	3.3	0
15	84.375	0	0	3.3	3.3	3.3	3.3	47	264.375	3.3	0	3.3	3.3	3.3	3.3
16	90	0	3.3	0	0	0	0	48	270	3.3	3.3	0	0	0	0
17	95.625	0	3.3	0	0	0	3.3	49	275.625	3.3	3.3	0	0	0	3.3
18	101.25	0	3.3	0	0	3.3	0	50	281.25	3.3	3.3	0	0	3.3	0
19	106.875	0	3.3	0	0	3.3	3.3	51	286.875	3.3	3.3	0	0	3.3	3.3
20	112.5	0	3.3	0	3.3	0	0	52	292.5	3.3	3.3	0	3.3	0	0
21	118.125	0	3.3	0	3.3	0	3.3	53	298.125	3.3	3.3	0	3.3	0	3.3
22	123.75	0	3.3	0	3.3	3.3	0	54	303.75	3.3	3.3	0	3.3	3.3	0
23	129.375	0	3.3	0	3.3	3.3	3.3	55	309.375	3.3	3.3	0	3.3	3.3	3.3
24	135	0	3.3	3.3	0	0	0	56	315	3.3	3.3	3.3	0	0	0
25	140.625	0	3.3	3.3	0	0	3.3	57	320.625	3.3	3.3	3.3	0	0	3.3
26	146.25	0	3.3	3.3	0	3.3	0	58	326.25	3.3	3.3	3.3	0	3.3	0
27	151.875	0	3.3	3.3	0	3.3	3.3	59	331.875	3.3	3.3	3.3	0	3.3	3.3
28	157.5	0	3.3	3.3	3.3	0	0	60	337.5	3.3	3.3	3.3	3.3	0	0
29	163.125	0	3.3	3.3	3.3	0	3.3	61	343.125	3.3	3.3	3.3	3.3	0	3.3
30	168.75	0	3.3	3.3	3.3	3.3	0	62	348.75	3.3	3.3	3.3	3.3	3.3	0
31	174.375	0	3.3	3.3	3.3	3.3	3.3	63	354.375	3.3	3.3	3.3	3.3	3.3	3.3

Typical on-wafer Sij parameters (state 0)

Tamb.= +25°C, V+ = +5V, V- = -5V

Freq (GHz)	S11 (dB)	PhS11 (°)	S12 (dB)	PhS12 (°)	S21 (dB)	PhS21 (°)	S22 (dB)	PhS22 (°)
5	-14,1	-41,3	-6,38	109	-6,38	109	-23,6	-40,3
5.2	-13,2	-48	-6,41	93	-6,41	93,2	-24,4	-19,3
5.4	-12,8	-54,4	-6,51	77,4	-6,51	77,4	-22,8	-1,55
5.6	-12,5	-61,9	-6,69	61,7	-6,69	61,8	-20,9	8,14
5.8	-12,3	-70,8	-7,06	46,4	-7,06	46,3	-19,9	13,3
6	-12,4	-86,3	-7,64	34,3	-7,66	34,3	-18,5	28,1
6.2	-14,5	-105	-7,46	24,1	-7,46	24,2	-15	26,8
6.4	-18	-115	-7,16	10,2	-7,16	10,3	-13,2	16,1
6.6	-22,6	-120	-7,07	-4,33	-7,07	-4,31	-12,4	6,63
6.8	-31	-106	-7,08	-18,7	-7,07	-18,7	-11,8	-0,352
7	-30	-5,47	-7,11	-32,7	-7,11	-32,7	-11,6	-6,88
7.2	-22,8	3	-7,13	-46,7	-7,12	-46,8	-11,4	-13,5
7.4	-19	-2,12	-7,17	-60,7	-7,18	-60,7	-11,4	-19,6
7.6	-16,4	-10,9	-7,2	-74,3	-7,2	-74,3	-11,4	-26,2
7.8	-14,8	-19,9	-7,22	-88,2	-7,22	-88,2	-11,5	-32,4
8	-13,6	-30,4	-7,23	-102	-7,24	-102	-11,8	-39,5
8.2	-12,9	-40,2	-7,26	-116	-7,25	-116	-12,1	-45,9
8.4	-12,4	-50,1	-7,28	-130	-7,28	-130	-12,6	-53,8
8.6	-12,2	-59,8	-7,31	-144	-7,29	-144	-13,2	-61,7
8.8	-12,1	-69,8	-7,28	-158	-7,29	-158	-13,9	-71,8
9	-12,1	-79	-7,28	-172	-7,29	-172	-15	-82,7
9.2	-12,3	-87,6	-7,31	174	-7,32	174	-16,2	-94,6
9.4	-12,6	-96	-7,35	160	-7,36	160	-17,8	-110
9.6	-12,8	-104	-7,41	145	-7,4	145	-19,6	-129
9.8	-13,1	-112	-7,49	131	-7,49	131	-21,2	-155
10	-13,2	-120	-7,57	116	-7,55	117	-22	172
10.2	-13,3	-128	-7,67	102	-7,64	102	-21,3	140
10.4	-13,3	-136	-7,78	87,6	-7,78	87,5	-19,8	112
10.6	-13,1	-145	-7,91	73,2	-7,89	73,1	-18,3	90,2
10.8	-13,1	-154	-8,04	58,9	-8,05	58,8	-17,1	73,2
11	-13	-164	-8,17	44,6	-8,17	44,7	-16,1	57,4
11.2	-12,9	-173	-8,3	30,3	-8,3	30,4	-15,5	43
11.4	-12,9	177	-8,43	16,2	-8,42	16,3	-15,2	28,7
11.6	-12,9	167	-8,53	2	-8,52	1,98	-15,3	14,2
11.8	-13	157	-8,64	-12,2	-8,63	-12,2	-15,7	-0,137
12	-13,1	147	-8,71	-26,5	-8,7	-26,5	-16,5	-17
12.2	-12,9	134	-8,81	-41,3	-8,8	-41,4	-18,2	-30,7
12.4	-13,1	126	-8,86	-55,8	-8,87	-55,8	-19,7	-55,8
12.6	-13,3	118	-8,93	-70,4	-8,94	-70,5	-21,2	-88,5
12.8	-13,5	110	-9,02	-85,2	-9,02	-85,2	-21	-128
13	-13,8	103	-9,09	-100	-9,08	-100	-19,1	-162
14	-16,5	75,4	-9,68	-173	-9,68	-173	-10,5	117
15	-29,3	43,8	-9,53	113	-9,52	113	-9,76	82,8

Typical Board Measurements

Tamb.= +25°C, V+ = +5V, V- = -5V

Insertion Loss versus Frequency @ All States
(after de-embedding of test-fixture insertion loss)

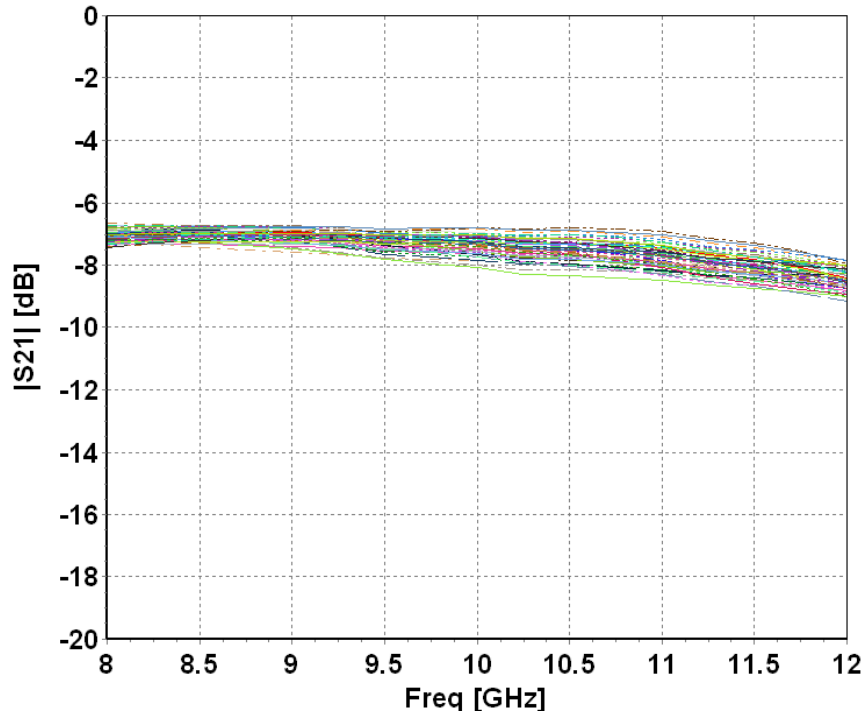

Input Return Losses @ All States

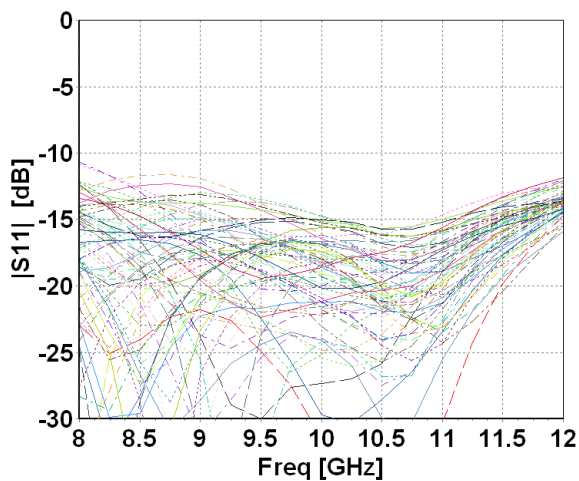

Output Return Losses @ All States

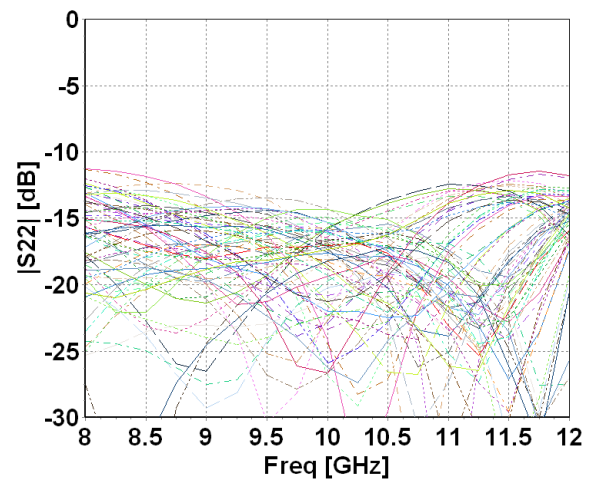

Typical Board Measurements

Temperature -40°C , $+25^{\circ}\text{C}$, $+85^{\circ}\text{C}$ $V_+ = +5\text{V}$, $V_- = -5\text{V}$

Insertion Loss versus Frequency @ State 0
(after de-embedding of test-fixture insertion loss)

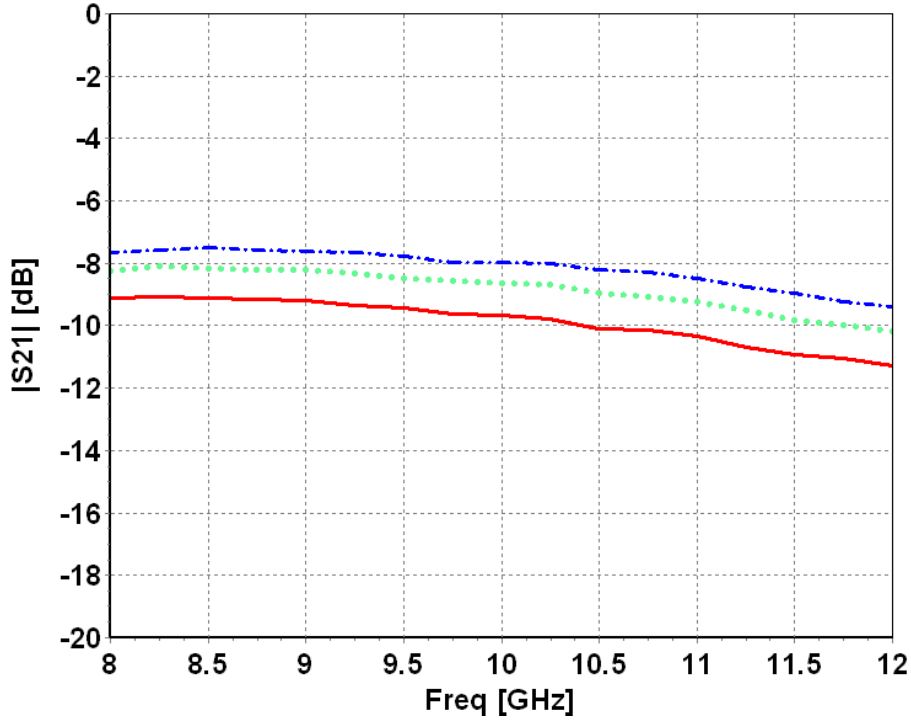

— -40°C +25°C — +85°C

Input Return Loss @ State 0

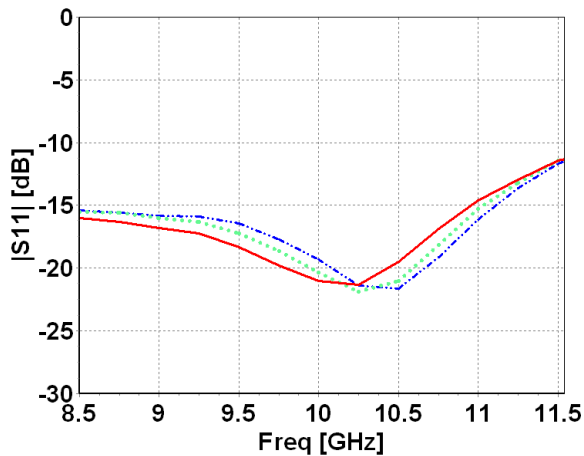

Output Return Loss @ State 0

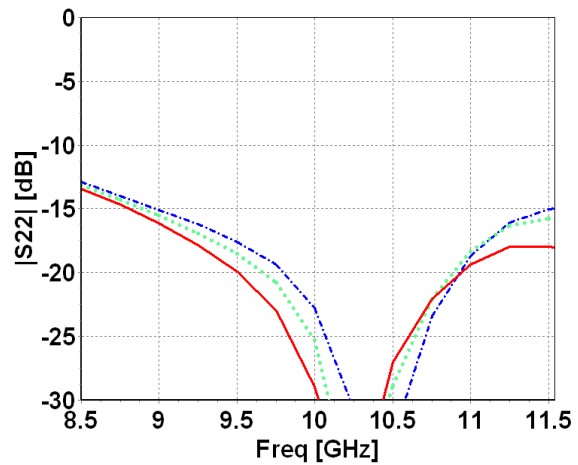

— -40°C +25°C — +85°C — -40°C +25°C — +85°C

Typical Board Measurements

Tamb.= +25°C, V+ = +5V, V- = -5V

Peak Phase Error versus Frequency
(all states)

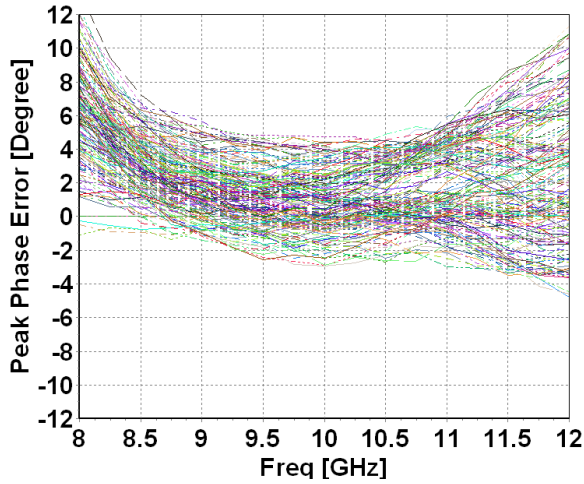

Peak Phase Error versus State

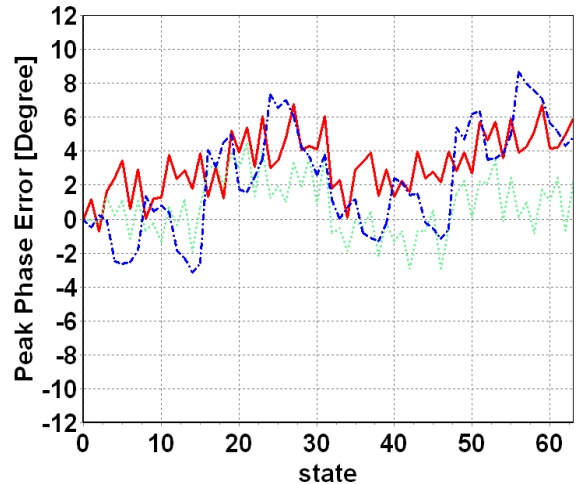

— 8.5GHz 10 GHz - - - 11.5GHz

RMS Phase Error versus Frequency

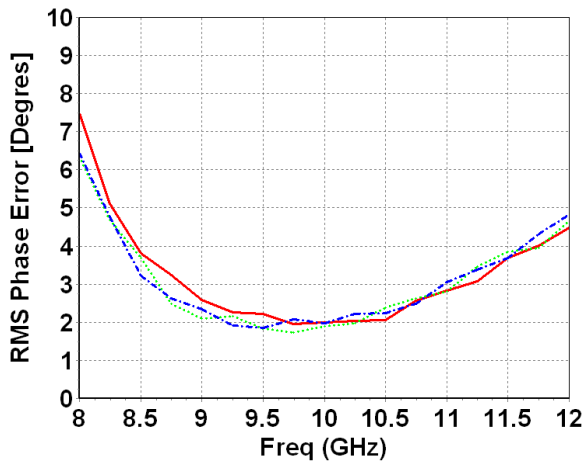

— -40°C ... +25°C — +85°C

Phase Shift versus State
(@ 10GHz)

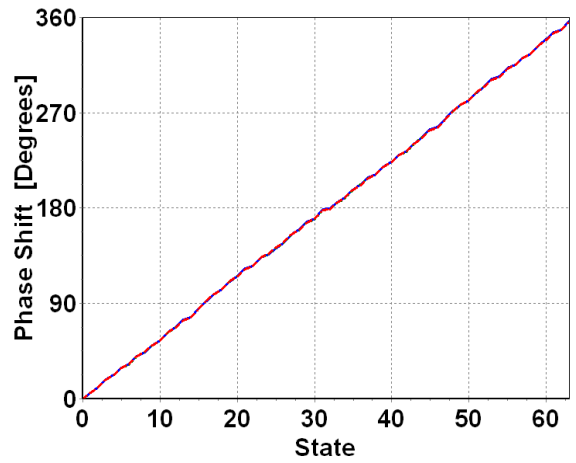

— -40°C ... +25°C — +85°C

Typical Board Measurements

Tamb.= +25°C, V+ = +5V, V- = -5V

Amplitude Variation versus Frequency (all states)

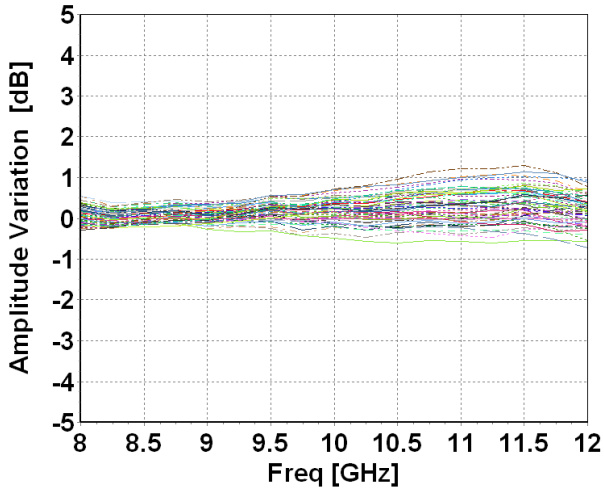

Amplitude Variation versus State

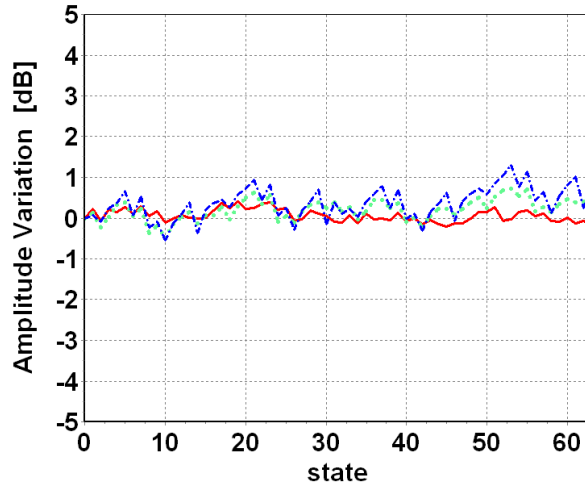

— 8.5GHz 10 GHz - - - 11.5GHz

RMS Amplitude Variation versus Frequency

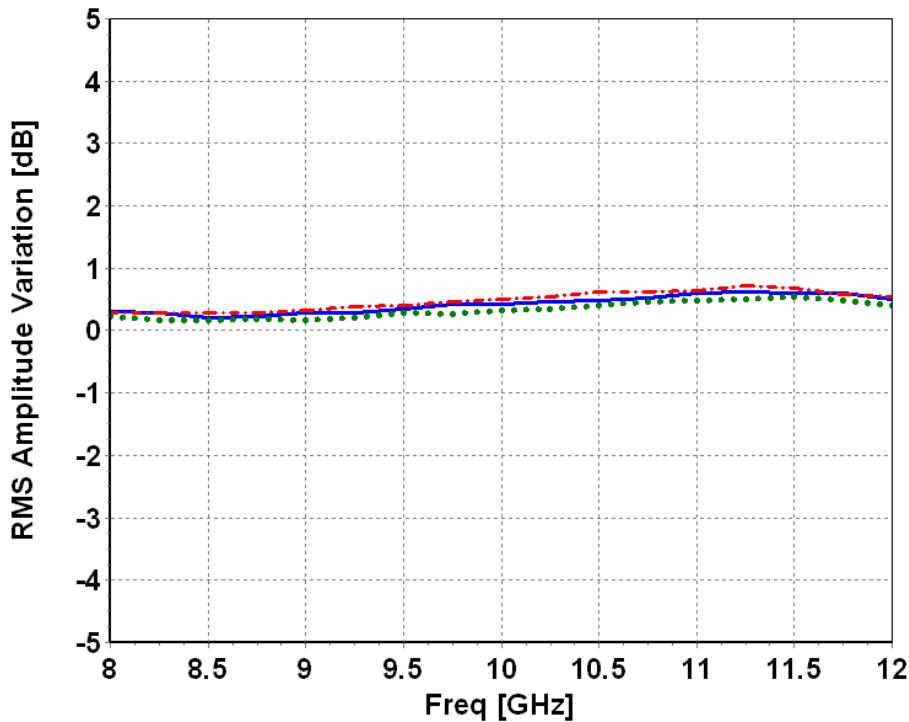

— -40°C +25°C - - - +85°C

Typical Board Measurements

Tamb.= +25°C, V+ = +5V, V- = -5V

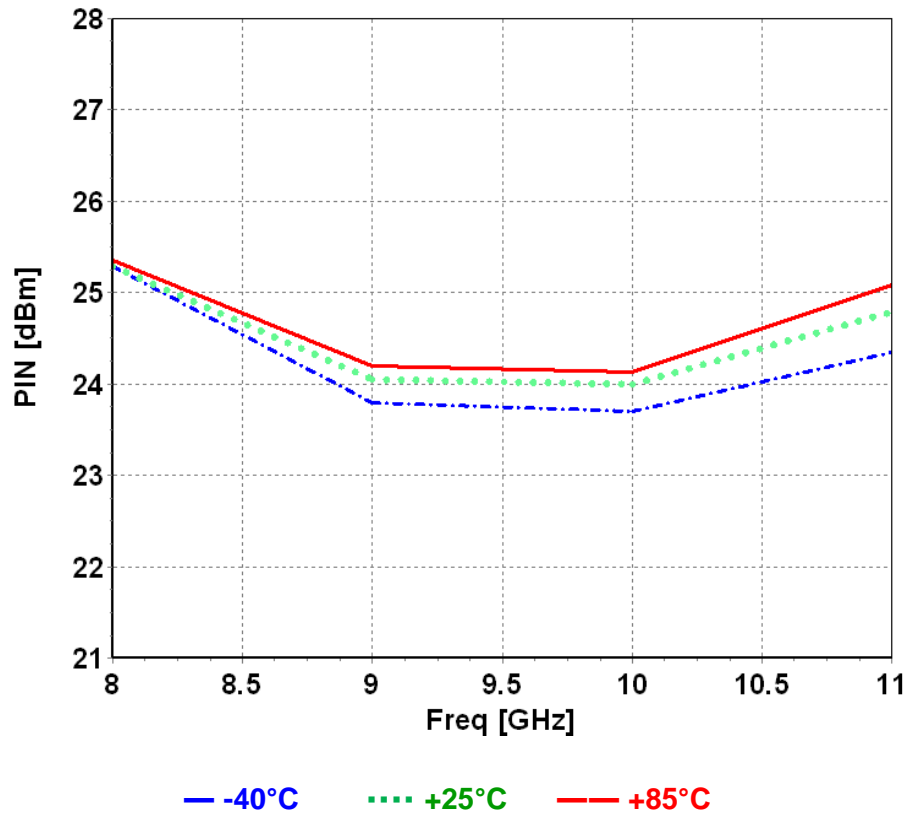
**Input Power @ 1dB compression
(reference state)**

Mechanical data

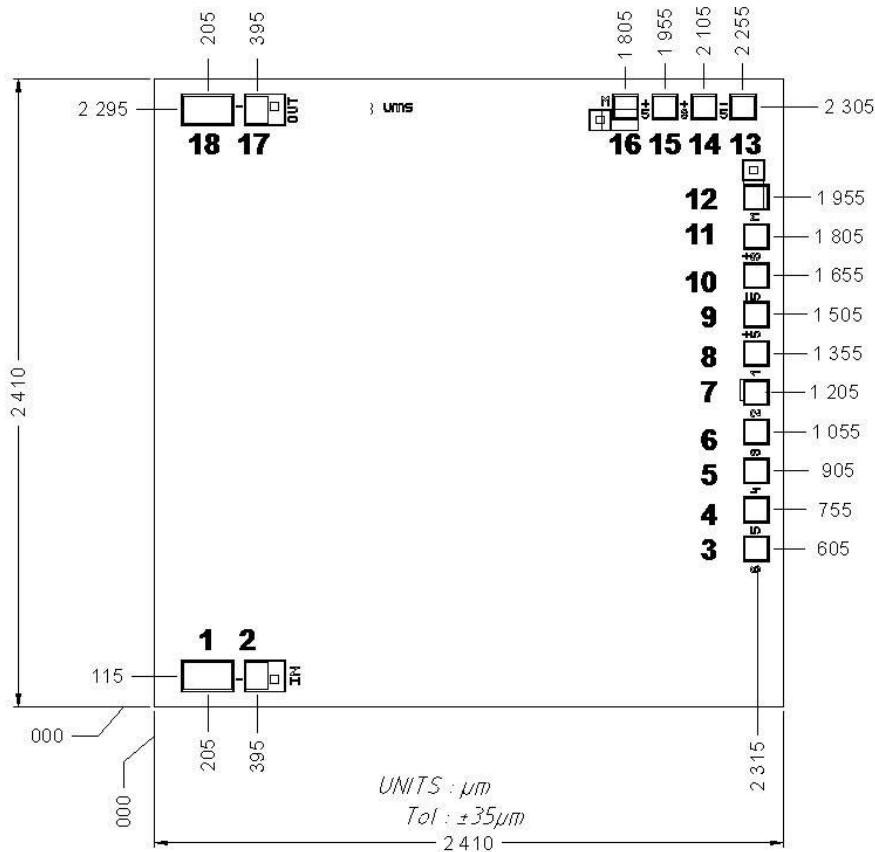

Chip thickness: 100 μm .
 Chip size: (2410 \pm 35) μm x (2410 \pm 35) μm
 All dimensions are in micrometers

Pad number	Pad name	Description
12, 16	M	Ground
2, 17		RF pad Ground
1	IN	RF input
9, 15	+5	+5V interface supply voltage (V+) *
11, 14	+3	+3.3V interface supply voltage (V+) *
10, 13	-5	-5V interface supply voltage (V-)
8	1	Bit 1
7	2	Bit 2
6	3	Bit 3
5	4	Bit 4
4	5	Bit 5
3	6	Bit 6
18	OUT	RF output

* only one of the two pads must be connected to the DC supply

Recommended assembly plan

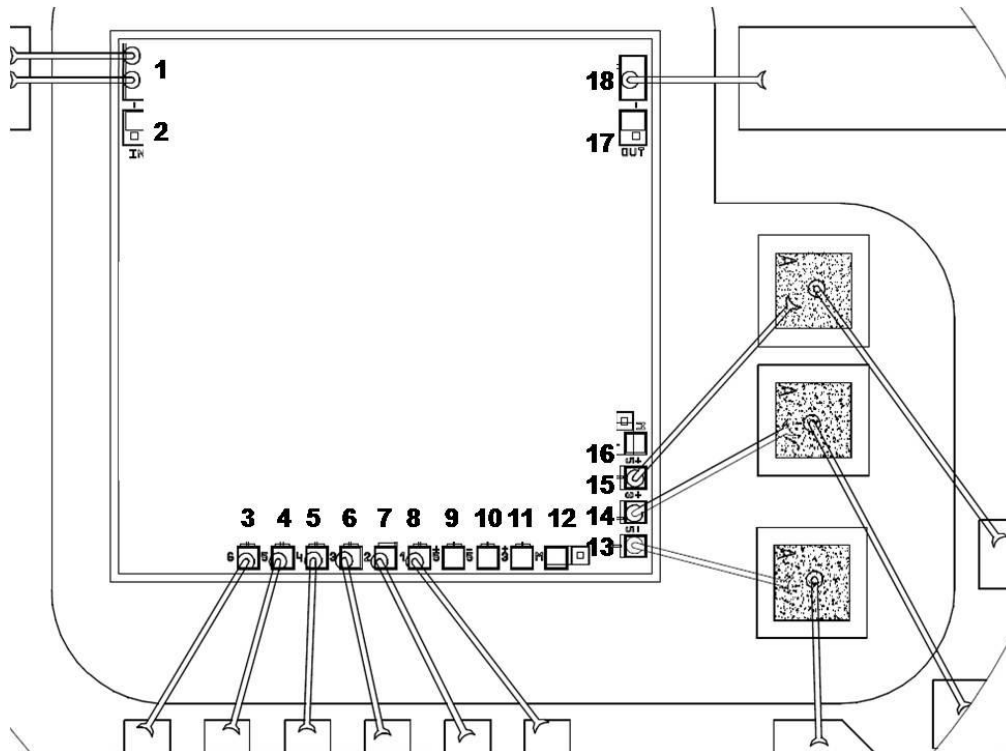

25µm wedge bonding is preferred

Notes: Supply feed should be bypassed. 25µm diameter gold wire is to be preferred

Pad number	Decoupling	Connection
18		2 parallel bonding wires (diameter=25µm, length=0.4mm)
1		1 bonding wire (diameter=25µm, length=0.4mm)
from 3 to 8		1 bonding wire (diameter=25µm, length=0.4mm)
13, 14, 15	120pF	1 bonding wire (diameter=25µm, length=0.4mm)

Evaluation mother board

- Based on typically Ro4003 / 8mils or equivalent.

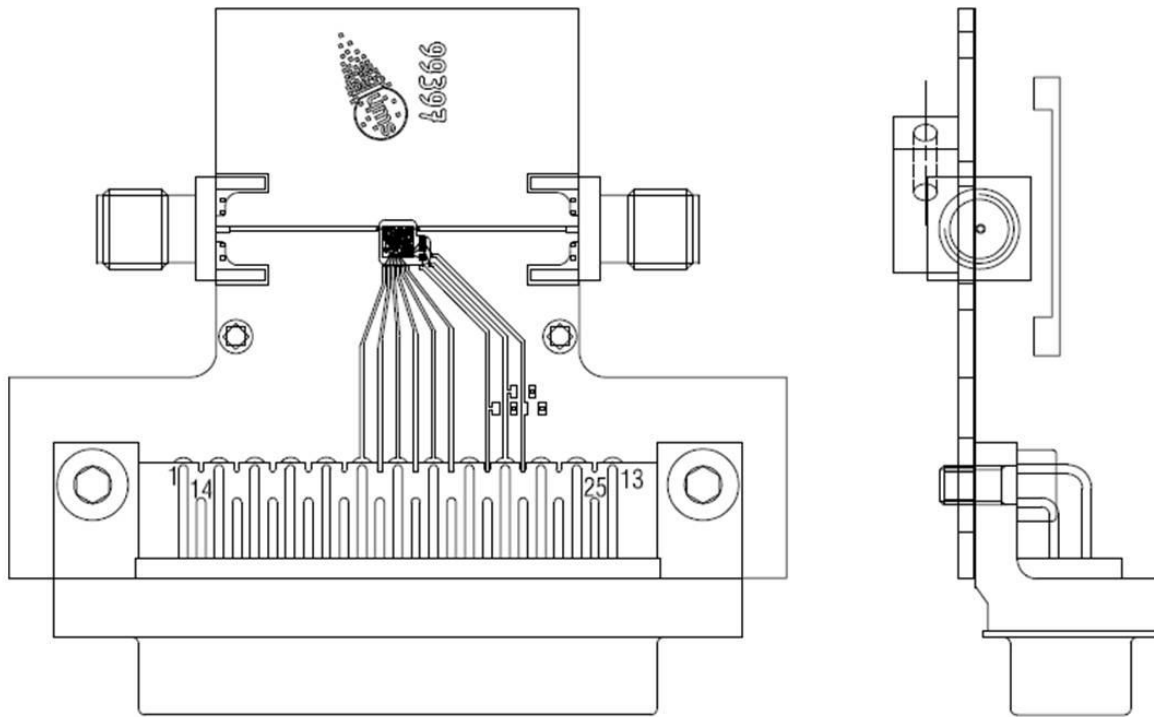

Notes

Recommended ESD management

Refer to the application note AN0020 available at <http://www.ums-gaas.com> for ESD sensitivity and handling recommendations for the UMS products.

Recommended environmental management

UMS products are compliant with the regulation in particular with the directives RoHS N°2011/65 and REACH N°1907/2006. More environmental data are available in the application note AN0019 also available at <http://www.ums-gaas.com>.

Ordering Information

Chip form:

CHP3015-99F/00

Information furnished is believed to be accurate and reliable. However **United Monolithic Semiconductors S.A.S.** assumes no responsibility for the consequences of use of such information nor for any infringement of patents or other rights of third parties which may result from its use. No license is granted by implication or otherwise under any patent or patent rights of **United Monolithic Semiconductors S.A.S.**. Specifications mentioned in this publication are subject to change without notice. This publication supersedes and replaces all information previously supplied. **United Monolithic Semiconductors S.A.S.** products are not authorised for use as critical components in life support devices or systems without express written approval from **United Monolithic Semiconductors S.A.S.**