

▪ **Outline Dimension Drawing**

Dimensions: mm[inch]

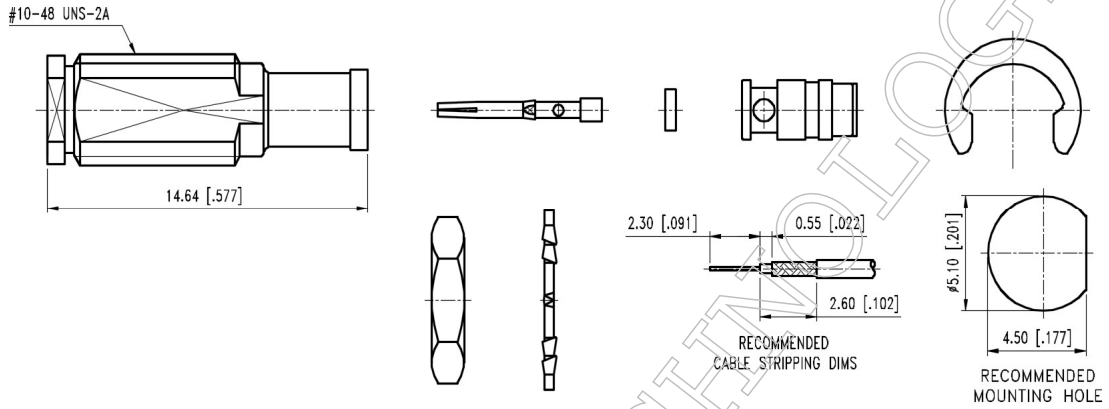

▪ **Material Specification**

Description	Material	Plating
Body	Brass	Gold
Contact	BeCu	Gold
Dielectric	PTFE	
Dielectric	PTFE	
Washer	Brass	Gold
Nut	Brass	Gold
R/ring	BeCu	Gold
Ferrule	Brass	Gold

In the effort to improve our products, we reserve the right to make changes judged to be necessary



▪ **Electrical Specification**

Description		Description	
Impedance	50 Ω	Insulation Resistance	1000 MΩ Min.
Frequency	6 GHz	Inner Contact Resistance	5 mΩ Max.
VSWR	1.3 Max.	Outer Contact Resistance	2.5 mΩ Max.
Insertion Loss	0.25 dB Max.		
Voltage Rating	170 Vrms Max.		
Dielectric Withstanding Voltage	500 Vrms Max.		

▪ **Mechanical Specification**

Description		Description	
Engagement Force	3.4 lbs. Max.		
Disengagement Force	1.4~3.4 lbs.		
Center Contact			
Axial Force-Mating End	N/A lbs.		
Axial Force-Opposite End	N/A lbs.		
Connector Durability	500 cycles		
Weight	N/A g		

▪ **Environmental Specification**

Description		Description	
Temperature Min.	-55 °C		
Temperature Max.	155 °C		
Hermetic Seal	N/A		

In the effort to improve our products, we reserve the right to make changes judged to be necessary