

▪ **Outline Dimension Drawing**

Dimensions: mm[inch]

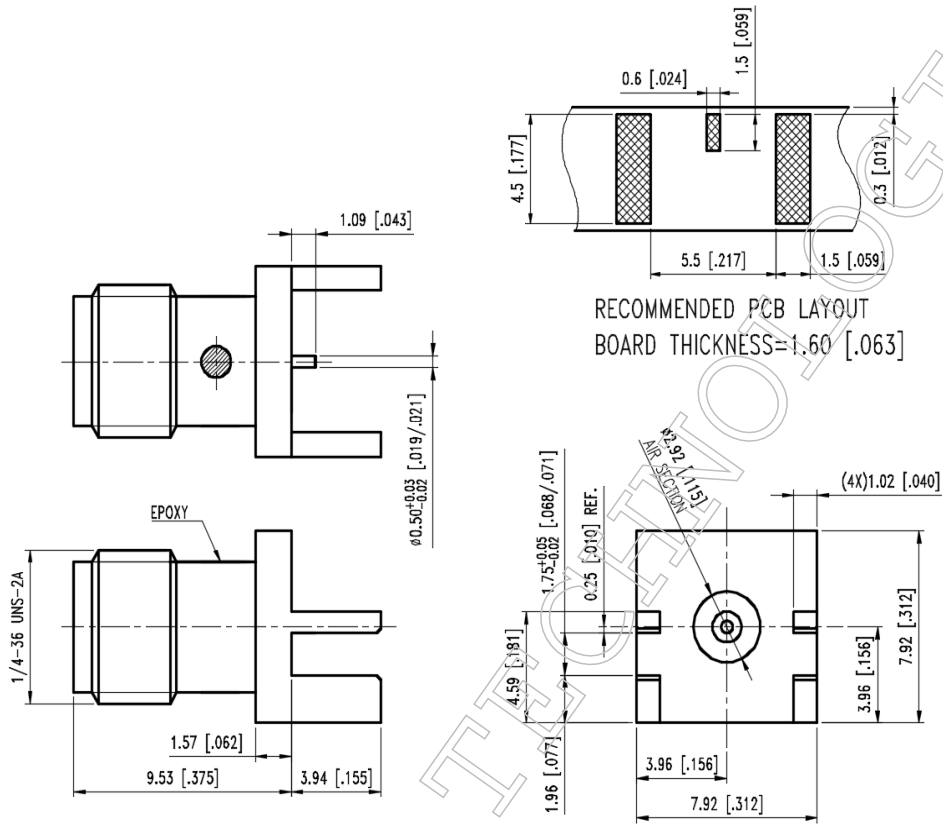

▪ **Material Specification**

Description	Material	Plating
Body	Brass	Gold
Contact	BeCu	Gold
Dielectric	PTFE	

In the effort to improve our products, we reserve the right to make changes judged to be necessary



▪ **Electrical Specification**

Description			Description		
Impedance	50	Ω	Insulation Resistance	5000	MΩ Min.
Frequency	26.5	GHz	Inner Contact Resistance	6	mΩ Max.
VSWR	1.4	Max.	Outer Contact Resistance	2	mΩ Max.
Insertion Loss	0.31	dB Max.	Voltage Rating	335	Vrms Max.
Dielectric Withstanding Voltage	750	Vrms Max.			

▪ **Mechanical Specification**

Description			Description		
Center Contact			Recommended Torque	7~9	in. lbs
Axial Force-Mating End	6	lbs.	Coupling Nut Retention	N/A	lbs. Min.
Axial Force-Opposite End	6	lbs.			
Connector Durability	500	cycles			
Weight	1.795	g			

▪ **Environmental Specification**

Description		
Temperature Min.	-65	°C
Temperature Max.	125	°C
Hermetic Seal	N/A	

In the effort to improve our products, we reserve the right to make changes judged to be necessary