

22WMT_Cu WR22 Waveguide Magic Tee 33-50GHz with Four Rectangular Waveguide Interfaces

WR22 Waveguide Magic Tee Operating From 33 to 50GHz with Four Rectangular Waveguide Interfaces

Product Information

SKU	22WMT_Cu
-----	----------

Description

Waveguide magic tee 22WMT_Cu, operating from 33 to 50GHz with, 40dB isolation, H-Plane VSWR 1.40:1 and E-Plane VSWR 1.60:1. 22WMT_Cu is a four-ports hybrid coupler or power divider. All the ports have standard WR22 waveguides with the same flanges FUGP400(UG-383/U). The magic tee can be used as a power combiner or a power divider based on the given application's needs.

Technical Specification

Electrical Specification		Interface	
WG Tee Type	Magic Tee	Flange 3 Style	Round
Waveguide Band	Q	Flange 3 Type	Cover
Waveguide Type	Rectangular	Flange 3 Designation	FUGP400(UG-383/U)
Waveguide Size EIA WR	WR22	Flange 4 Style	Round
Frequency, Min (GHz)	33	Flange 4 Type	Cover
Frequency, Max (GHz)	50	Flange 4 Designation	FUGP400(UG-383/U)
I.L., Max (dB)	0.6	Mechanical Specification	
VSWR, H-Plane, Typ	1.4	Body Material	Cu
VSWR, H-Plane, Typ	1.40:1	Size, L (mm)	35.1
VSWR, E-Plane, Typ	1.6	Size, W (mm)	35.1
VSWR, E-Plane, Typ	1.60:1	Size, H (mm)	35.1
Isolation, Min (dB)	30	Weight, (kg)	0.35
Isolation, Typ (dB)	40	Pressure Sealed	No
Power Handling, CW, (W)	25	Environmental Specification	
Power Handling, Peak, (KW)	15	Operating Temp. Low (°C)	-55
Interface		Operating Temp. High (°C)	85
Flange 1 Style	Round	Storage Temp. Low (°C)	-60
Flange 1 Type	Cover	Storage Temp. High (°C)	90
Flange 1 Designation	FUGP400(UG-383/U)		
Flange 2 Style	Round		
Flange 2 Type	Cover		
Flange 2 Designation	FUGP400(UG-383/U)		

Additional Information

Application	General Purpose Indoor & Outdoor, Fixed
-------------	---

Outline Drawing(Size: mm)

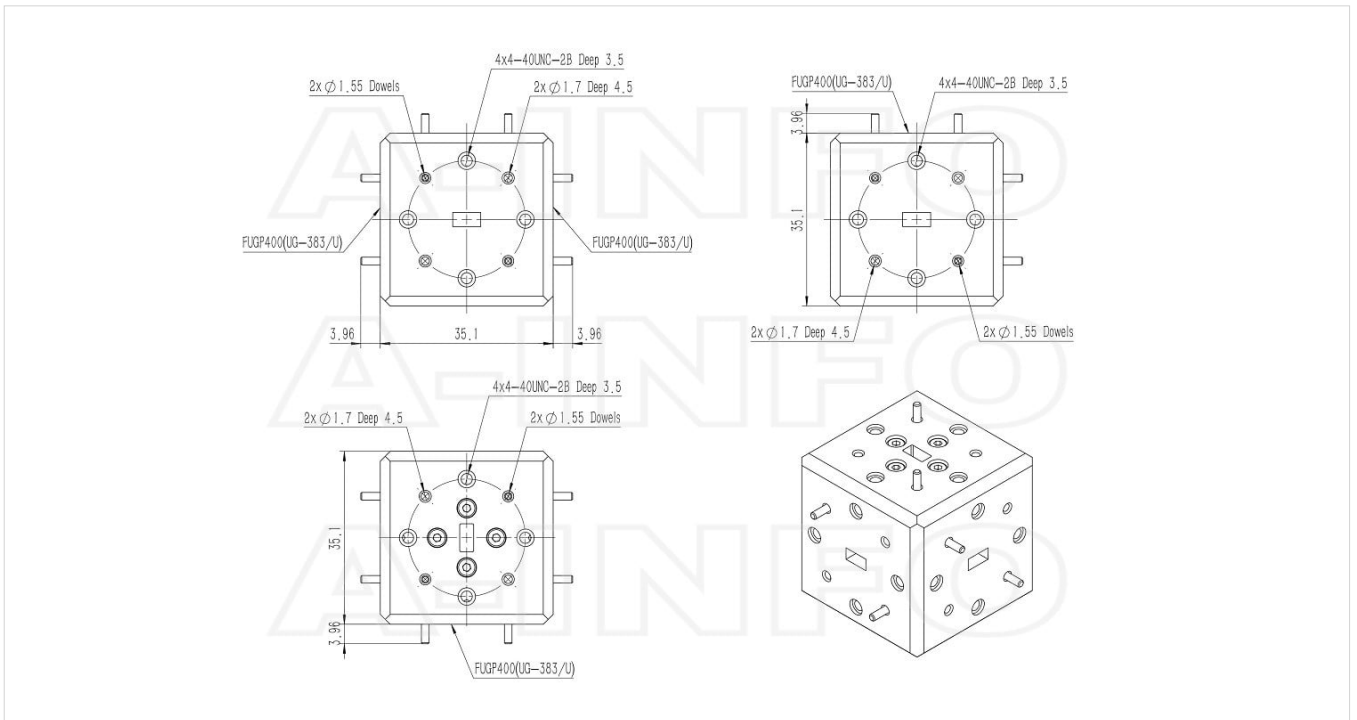

Flange Drawing(Size: mm)

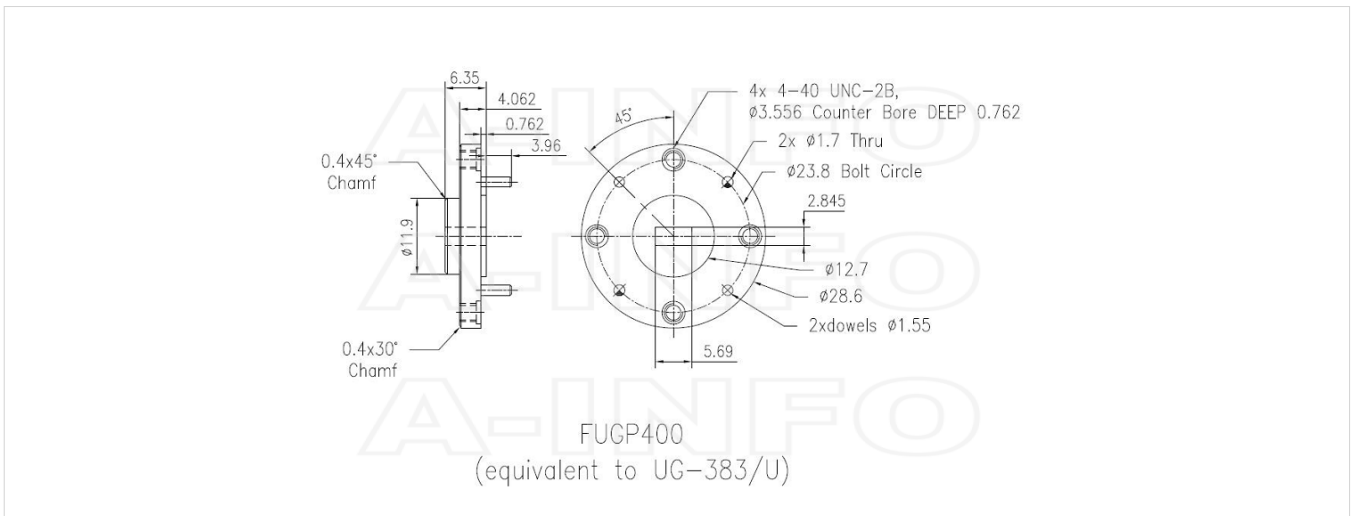

Typical Test Results

Insertion Loss(Including the theoretical loss 3.0dB)

E-Plane

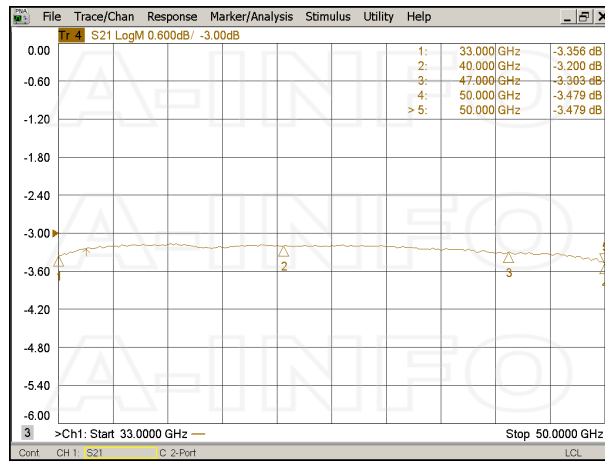

H-Plane

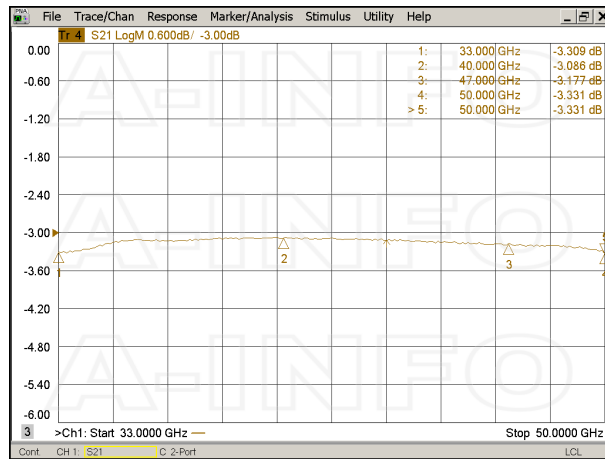

VSWR

E-Plane

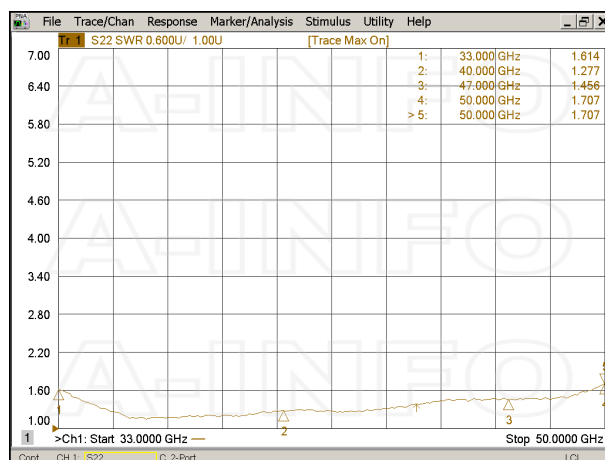

H-Plane

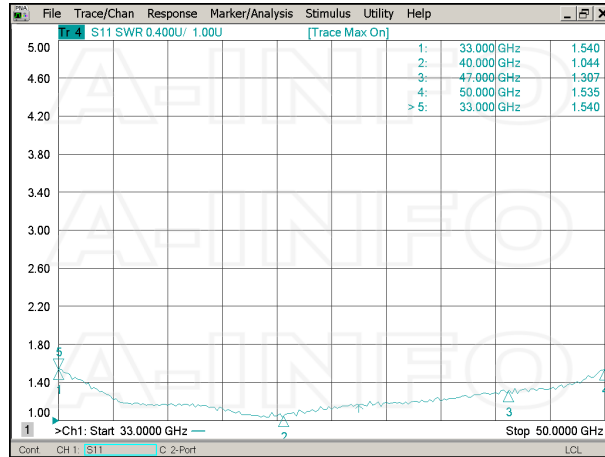

Unbalance

E-Plane

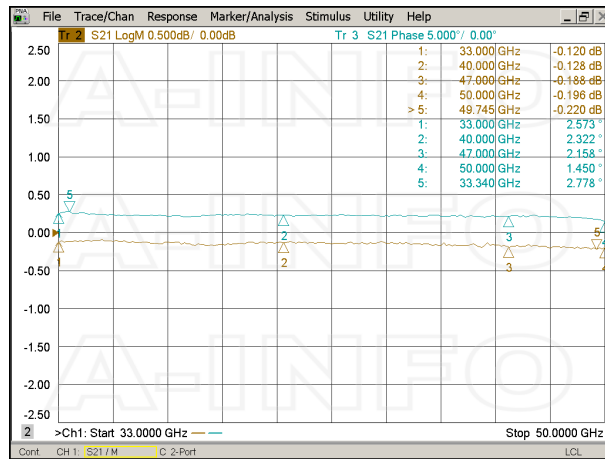

H-Plane

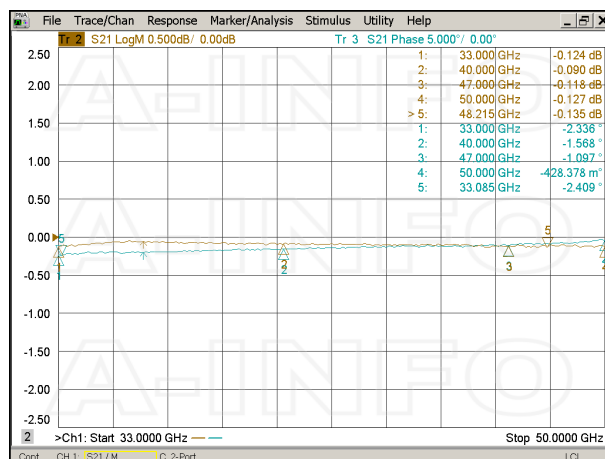

Isolation

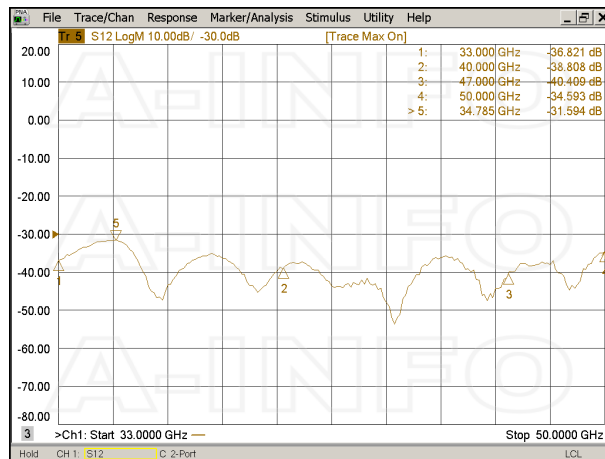

Similar Products



22WET_Cu WR22 Waveguide E-Plane Tee 33-50GHz with Three Rectangular Waveguide Interfaces



28WET_Cu WR28 Waveguide E-Plane Tee 26.5-40GHz with Three Rectangular Waveguide Interfaces



28WHT_Cu WR28 Waveguide H-Plane Tee 26.5-40GHz with Three Rectangular Waveguide Interfaces



28WMT_Cu WR28 Waveguide Magic Tee 26.5-40GHz with Four Rectangular Waveguide Interfaces



19WMT_Cu WR19 Waveguide Magic Tee 40-60GHz with Four Rectangular Waveguide Interfaces



19WET_Cu WR19 Waveguide E-Plane Tee 40-60GHz with Three Rectangular Waveguide Interfaces

About this Datasheet

<ul style="list-style-type: none">● Product Information <p>Product Link: https://www.ainfoinc.com/22wmt-cu-wr22-waveguide-magic-tee-33-50-ghz-fugp400-ug-383-u Data subject to change without notice. © A-INFO INC. 2024. All Rights Reserved</p>	<ul style="list-style-type: none">● Contact Us <p>Address: 60 Tesla, Irvine, CA 92618, USA</p> <p>Website: www.ainfoinc.com</p> <p>Email: sales@ainfoinc.com</p>	<ul style="list-style-type: none">● Phone & Fax <p>Phone: +1-949-639-9688 +1-949-639-9608</p> <p>Fax: +1-949-639-9670</p>
--	---	--