

3 W High Linearity and High Efficiency GaAs Power FETs

FEATURES

- 3W Typical Power at 6 GHz
- Linear Power Gain: $G_L = 11$ dB Typical at 6 GHz
- High Linearity: $IP_3 = 45$ dBm Typical at 6 GHz
- Via Hole Source Ground
- Suitable for High Reliability Application
- Breakdown Voltage: $BV_{DGO} \geq 18$ V
- $L_g = 0.6 \mu\text{m}^*$, $W_g = 7.5$ mm
- High Power Added Efficiency: Nominal PAE of 43 % at 6 GHz
- Tight V_p ranges control
- High RF input power handling capability
- 100 % DC Tested

PHOTO ENLARGEMENT

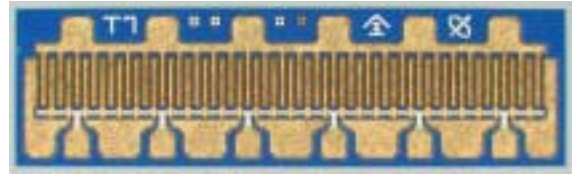

DESCRIPTION

The TC1706 is a GaAs Pseudomorphic High Electron Mobility Transistor (PHEMT), which has high linearity and high Power Added Efficiency. The device is processed with a propriety via-hole process, which provides low thermal resistance and low inductance. The long gate length makes the device to have high breakdown voltage. All devices are 100% DC tested to assure consistent quality. Bond pads are gold plated for either thermo-compression or thermo-sonic wire bonding. Backside gold plating is compatible with standard AuSn die-attach. Typical applications include commercial and military high performance power amplifiers.

ELECTRICAL SPECIFICATIONS ($T_A=25^\circ\text{C}$)

Symbol	Conditions	MIN	TYP	MAX	UNIT
P_{1dB}	Output Power at 1dB Gain Compression Point, $f = 6$ GHz $V_{DS} = 8$ V, $I_{DS} = 750$ mA	34.5	35.5		dBm
G_L	Linear Power Gain, $f = 6$ GHz $V_{DS} = 8$ V, $I_{DS} = 750$ mA	10	11		dB
IP_3	Intercept Point of the 3 rd -order Intermodulation, $f = 6$ GHz $V_{DS} = 8$ V, $I_{DS} = 750$ mA, $**P_{SCL} = 21$ dBm		45		dBm
PAE	Power Added Efficiency at 1dB Compression Power, $f = 6$ GHz		43		%
I_{DSS}	Saturated Drain-Source Current at $V_{DS} = 2$ V, $V_{GS} = 0$ V		1.8		A
g_m	Transconductance at $V_{DS} = 2$ V, $V_{GS} = 0$ V		1275		mS
V_P	Pinch-off Voltage at $V_{DS} = 2$ V, $I_D = 15$ mA		-1.7***		Volts
BV_{DGO}	Drain-Gate Breakdown Voltage at $I_{DGO} = 3.75$ mA	18	22		Volts
R_{th}	Thermal Resistance		4		$^\circ\text{C}/\text{W}$

Note:

* FET with $0.35 \mu\text{m}$ gate length is available for high frequency operation. Please contact factory for detail.

** P_{SCL} : Output Power of Single Carrier Level.

*** For the tight control of the pinch-off voltage. TC1706's are divided into 3 groups:

(1) **TC1706P1519** : $V_p = -1.5$ V to -1.9 V (2) **TC1706P1620** : $V_p = -1.6$ V to -2.0 V

(3) **TC1706P1721** : $V_p = -1.7$ V to -2.1 V In addition, the customers may specify their requirements.

ABSOLUTE MAXIMUM RATINGS (T_A=25 °C)

Symbol	Parameter	Rating
V _{DS}	Drain-Source Voltage	12 V
V _{GS}	Gate-Source Voltage	-5 V
I _{DS}	Drain Current	I _{DSS}
P _{in}	RF Input Power, CW	31.5 dBm
P _T	Continuous Dissipation	11.5 W
T _{CH}	Channel Temperature	175 °C
T _{STG}	Storage Temperature	- 65 °C to +175 °C

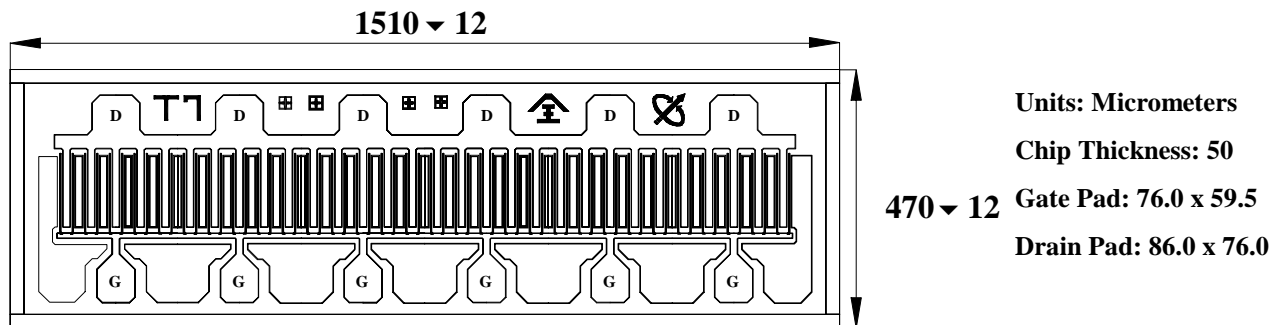
CHIP DIMENSIONS

CHIP HANDLING

DIE ATTACHMENT: Conductive epoxy or eutectic die attach is recommended. Eutectic die attach can be accomplished with Au-Sn (80% Au-20% Sn) perform at stage temperature: 290°C ± 5°C; Handling Tool: Tweezers; Time: less than 1min.

WIRE BONDING: The recommended wire bond method is thermocompression bonding with 0.7 to 1.0 mil (0.018 to 0.025 mm) gold wire. Stage temperature: 220°C to 250°C; Bond Tip Temperature: 150°C; Bond Force: 20 to 30 gms depending on size of wire and Bond Tip Temperature.

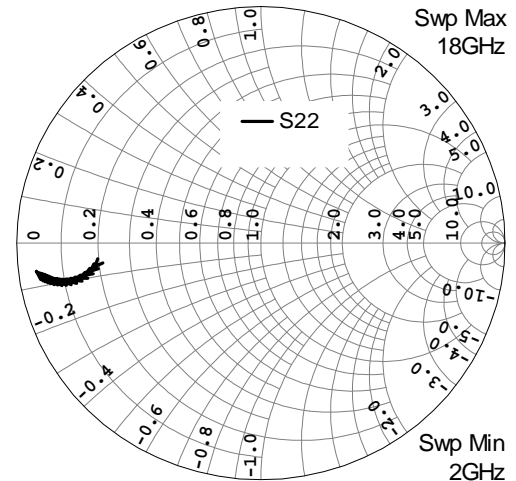
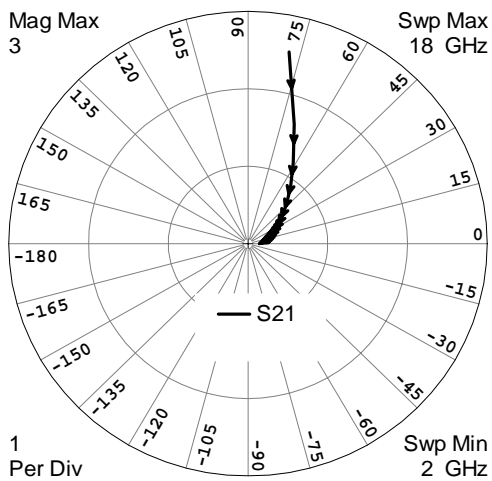
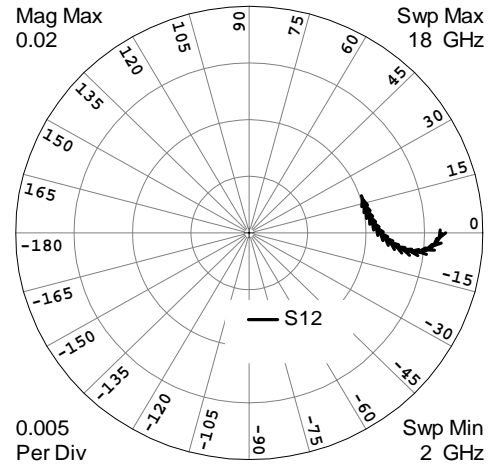
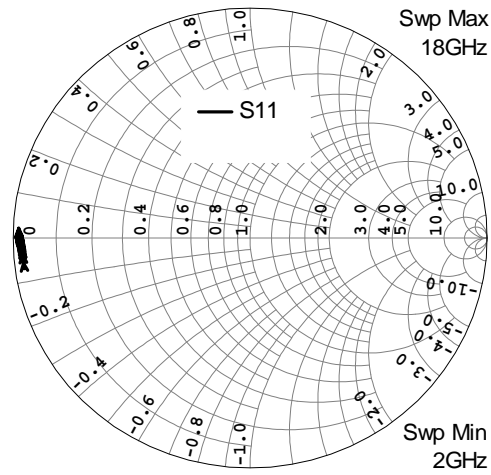
HANDLING PRECAUTIONS: The user must operate in a clean, dry environment. Care should be exercised during handling avoid damage to the devices. Electrostatic Discharge (ESD) precautions should be observed at all stages of storage, handling, assembly, and testing. The static discharge must be less than 300V.

TYPICAL SCATTERING PARAMETERS ($T_A=25\text{ }^\circ\text{C}$) $V_{DS} = 8\text{ V}$, $I_{DS} = 750\text{ mA}$

FREQUENCY (GHz)	S11		S21		S12		S22	
	MAG	ANG	MAG	ANG	MAG	ANG	MAG	ANG
0.05	0.99534	-38.565	34.809	159.97	0.0056861	70.259	0.38223	-164.03
0.1	0.98622	-69.959	30.076	143.72	0.0098259	54.292	0.46827	-160.28
0.2	0.97253	-108.9	21.191	123.5	0.013846	34.653	0.57268	-163.71
0.3	0.96632	-129.07	15.622	112.78	0.015311	24.509	0.61412	-167.19
0.4	0.96342	-140.71	12.198	106.31	0.015941	18.615	0.63271	-169.39
0.5	0.96192	-148.14	9.9507	101.92	0.016255	14.8	0.64251	-170.76
0.6	0.96106	-153.26	8.3803	98.668	0.016427	12.125	0.64843	-171.63
0.7	0.96054	-156.99	7.227	96.103	0.016528	10.136	0.65243	-172.2
0.8	0.96021	-159.83	6.3465	93.979	0.016587	8.5891	0.65542	-172.56
0.9	0.95999	-162.05	5.6531	92.156	0.016622	7.3428	0.65783	-172.79
1	0.95984	-163.84	5.0934	90.547	0.01664	6.3104	0.65993	-172.91
1.1	0.95975	-165.32	4.6322	89.095	0.016647	5.4359	0.66184	-172.97
1.2	0.95969	-166.55	4.2457	87.763	0.016645	4.6812	0.66366	-172.97
1.3	0.95966	-167.6	3.9171	86.524	0.016636	4.0198	0.66544	-172.93
1.4	0.95966	-168.51	3.6342	85.359	0.016622	3.4328	0.6672	-172.86
1.5	0.95966	-169.29	3.3882	84.255	0.016604	2.906	0.66898	-172.77
1.6	0.95968	-169.98	3.1723	83.2	0.016582	2.4291	0.67079	-172.66
1.7	0.95971	-170.59	2.9811	82.186	0.016557	1.994	0.67263	-172.54
1.8	0.95975	-171.14	2.8107	81.207	0.016529	1.5944	0.67453	-172.4
1.9	0.9598	-171.63	2.6578	80.259	0.016498	1.2255	0.67647	-172.26
FREQUENCY	S11		S21		S12		S22	

(GHz)	MAG	ANG	MAG	ANG	MAG	ANG	MAG	ANG
2	0.95986	-172.07	2.5198	79.338	0.016465	0.8833	0.67846	-172.12
3	0.9629	-174.84	1.6459	69.42	0.0161	-3.15	0.6973	-170.93
4	0.9642	-176.34	1.1945	61.60	0.0155	-5.08	0.7212	-169.73
5	0.9656	-177.31	0.9188	54.48	0.0149	-6.26	0.7465	-168.93
6	0.9670	-178.03	0.7329	47.95	0.0142	-6.78	0.7714	-168.53
7	0.9684	-178.61	0.5996	41.96	0.0136	-6.69	0.7948	-168.42
8	0.9697	-179.11	0.5000	36.46	0.0130	-6.03	0.8162	-168.54
9	0.9709	-179.55	0.4233	31.41	0.0124	-4.86	0.8352	-168.80
10	0.9719	-179.95	0.3629	26.78	0.0119	-3.23	0.8520	-169.16
11	0.9729	179.67	0.3145	22.51	0.0114	-1.19	0.8667	-169.58
12	0.9737	179.32	0.2751	18.58	0.0110	1.18	0.8795	-170.02
13	0.9745	178.98	0.2426	14.95	0.0107	3.82	0.8906	-170.47
14	0.9751	178.65	0.2155	11.60	0.0105	6.67	0.9003	-170.93
15	0.9757	178.34	0.1927	8.49	0.0103	9.65	0.9087	-171.37
16	0.9762	178.04	0.1734	5.61	0.0102	12.70	0.9160	-171.80
17	0.9766	177.74	0.1567	2.94	0.0101	15.77	0.9225	-172.21
18	0.9770	177.45	0.1424	0.46	0.0101	18.81	0.9282	-172.61

* The data does not include gate, drain and source bond wires.

SMALL SIGNAL MODEL, $V_{DS} = 8\text{ V}$, $I_{DS} = 750\text{ mA}$ SCHEMATI

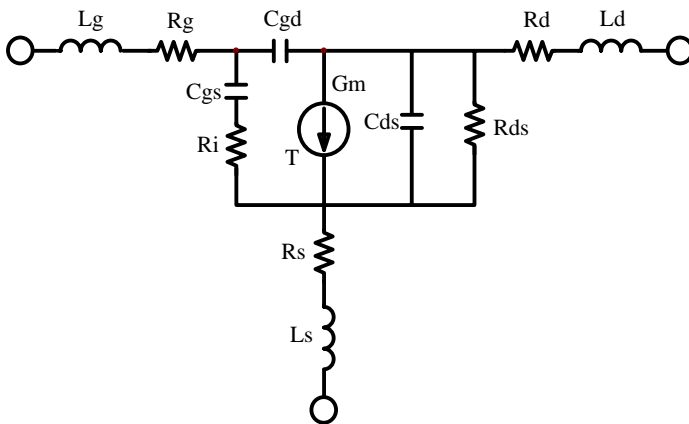

PARAMETERS

Lg	0.014 nH	Rs	0.177 Ohm
Rg	0.155 Ohm	Ls	0.002 nH
Cgs	13.74 pF	Cds	1.786 pF
Ri	0.308 Ohm	Rds	19.83 Ohm
Cgd	0.482 pF	Rd	0.233 Ohm
Gm	1401 mS	Ld	0.002 nH
T	3.9 psec		