

Technical Specification



The picture is for reference only.

Frequency Range(GHz)	0.2 - 1.0
Gain(dB)	7 Typ.
Polarization	Dual Pol.
VSWR	2.0:1 Typ.
Connector	N -Female
Size(mm)	857x857x1120
Net Weight(Kg)	4.0 Around

Outline Drawing (Size: mm)

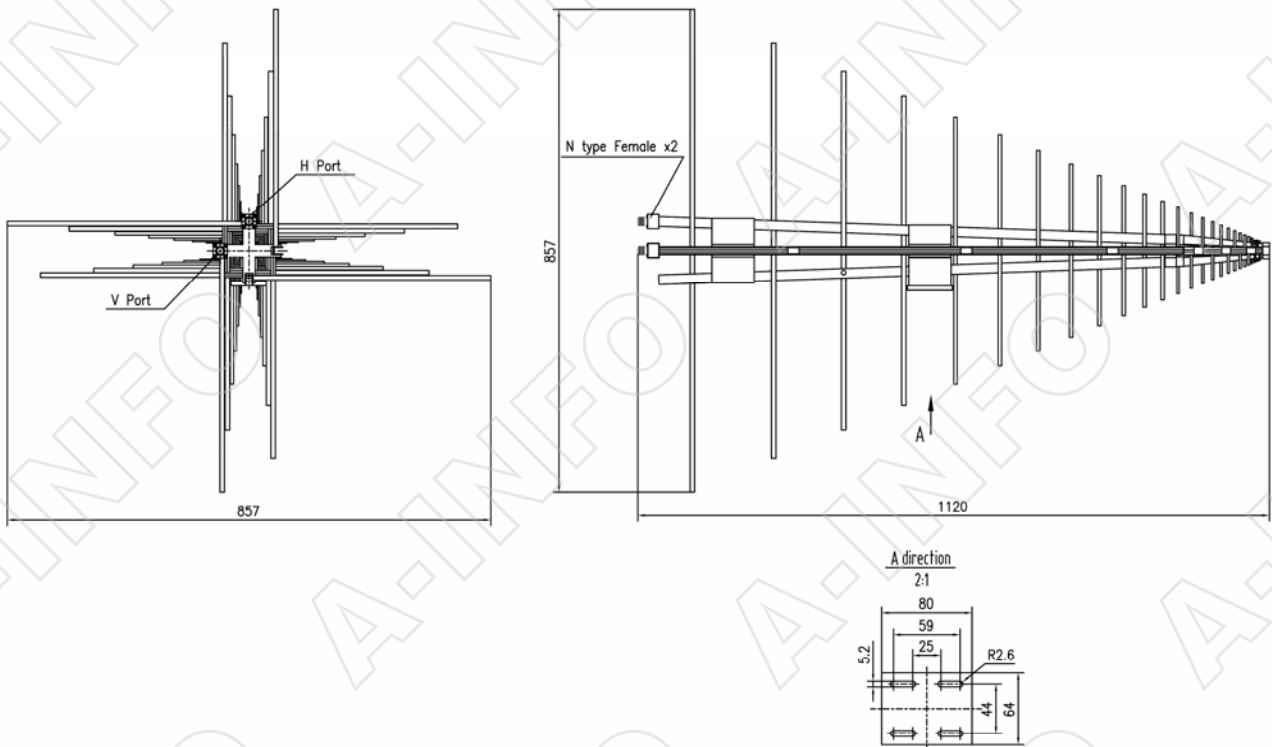

Test Results

1. Gain

Gain at 1 m

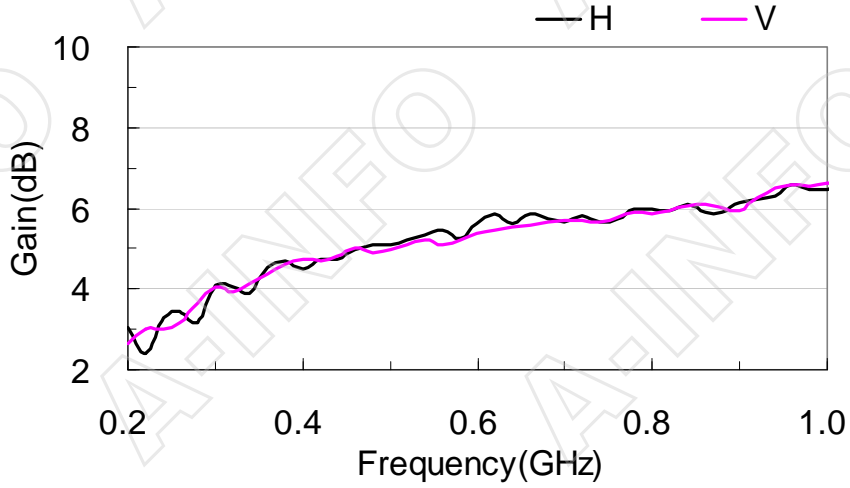

Gain at 3 m

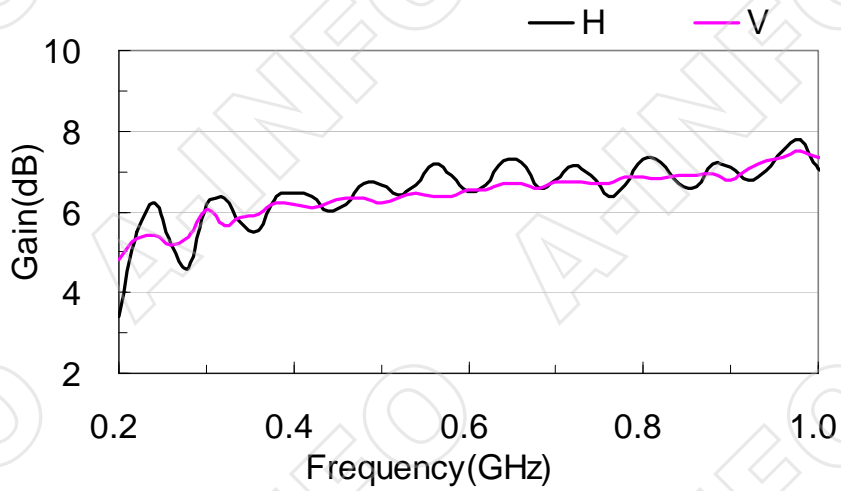

Gain at 10 m

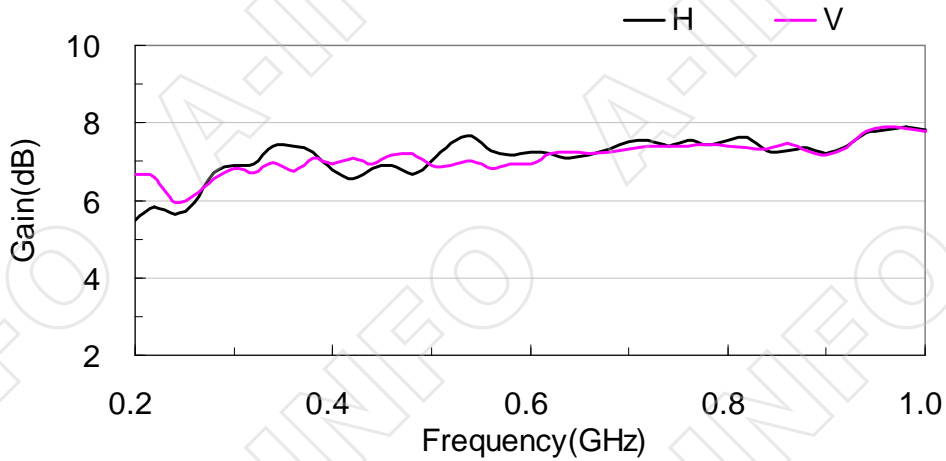

2. Antenna Factor

AF at 1 m

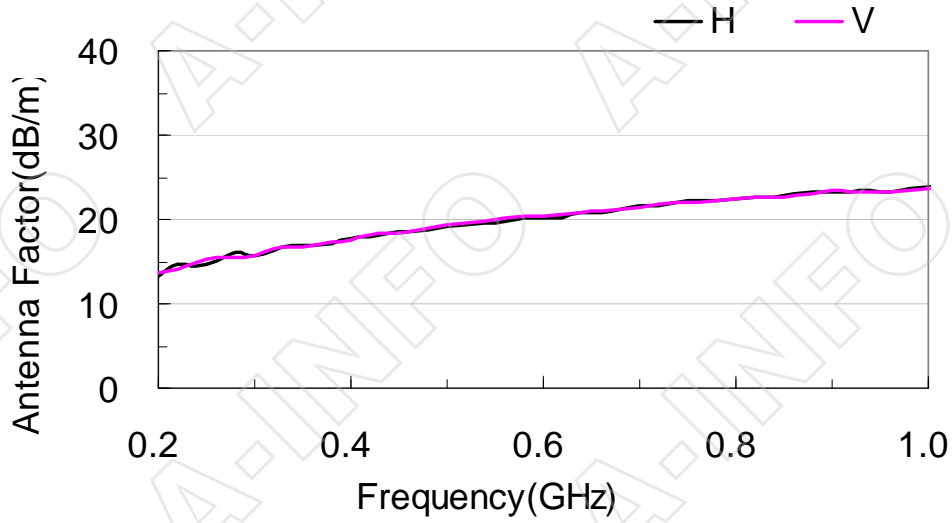

AF at 3 m

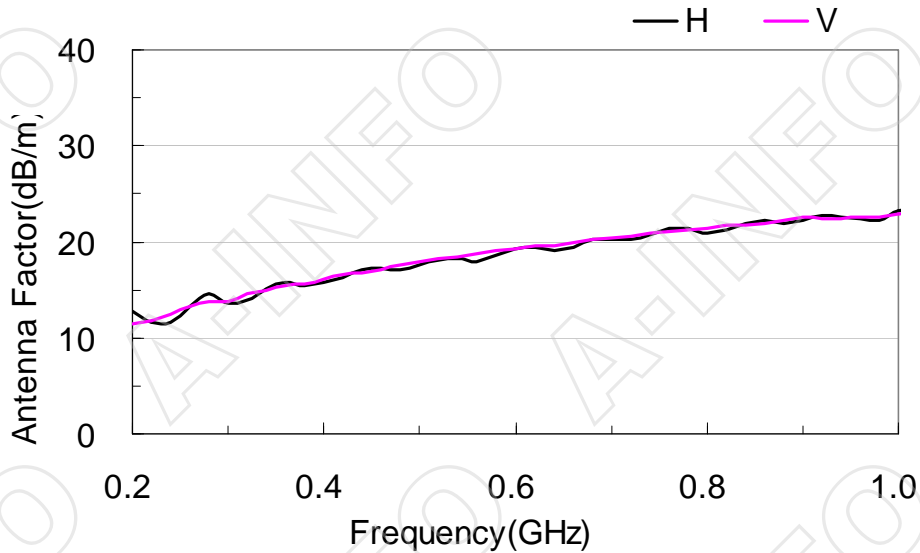

AF at 10 m

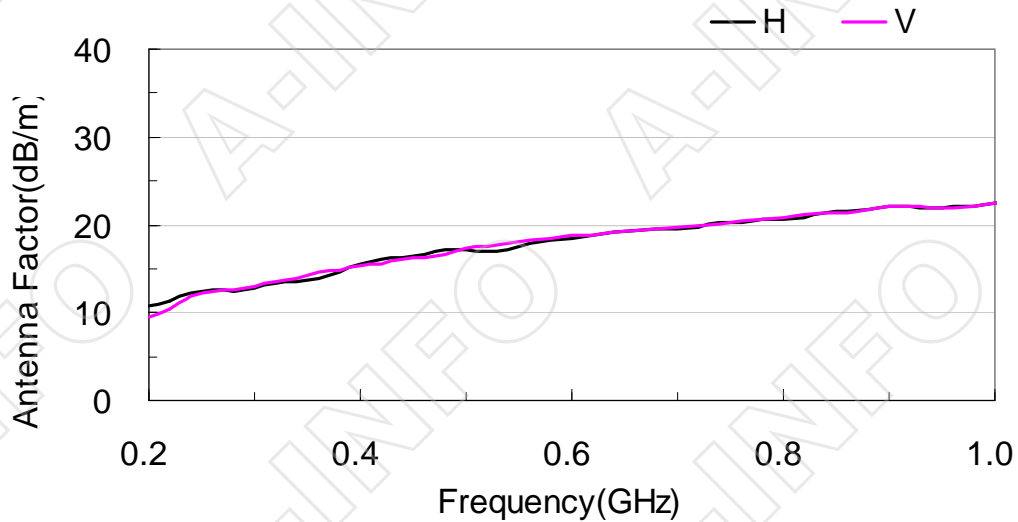

3. VSWR H Port

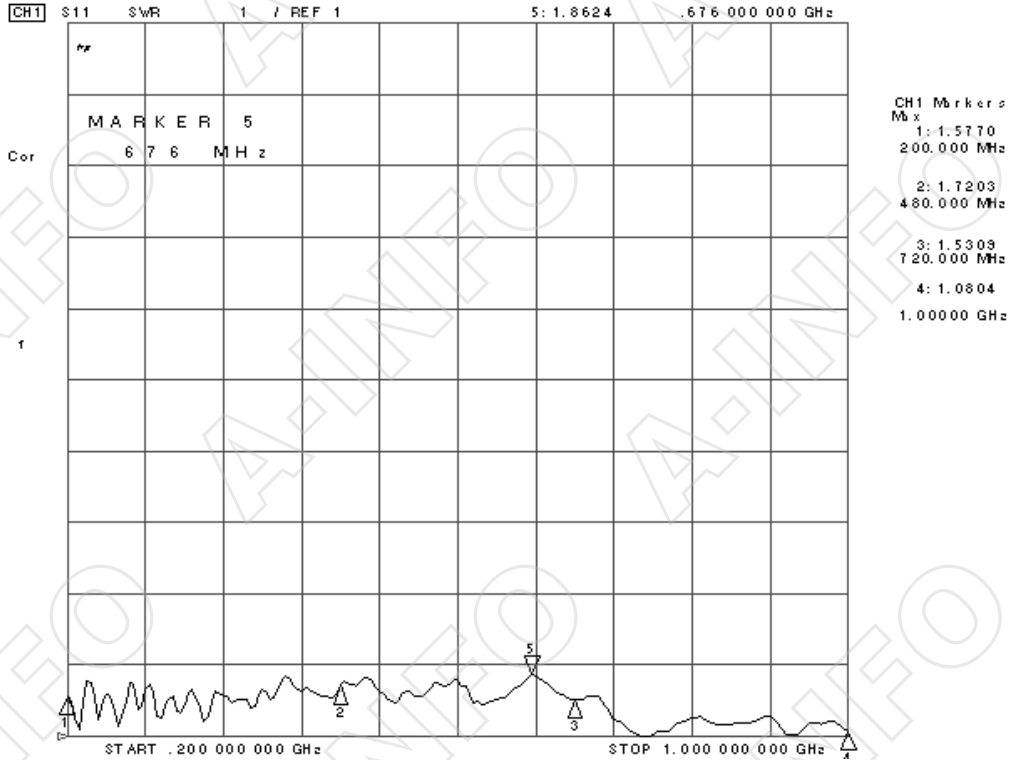

V Port

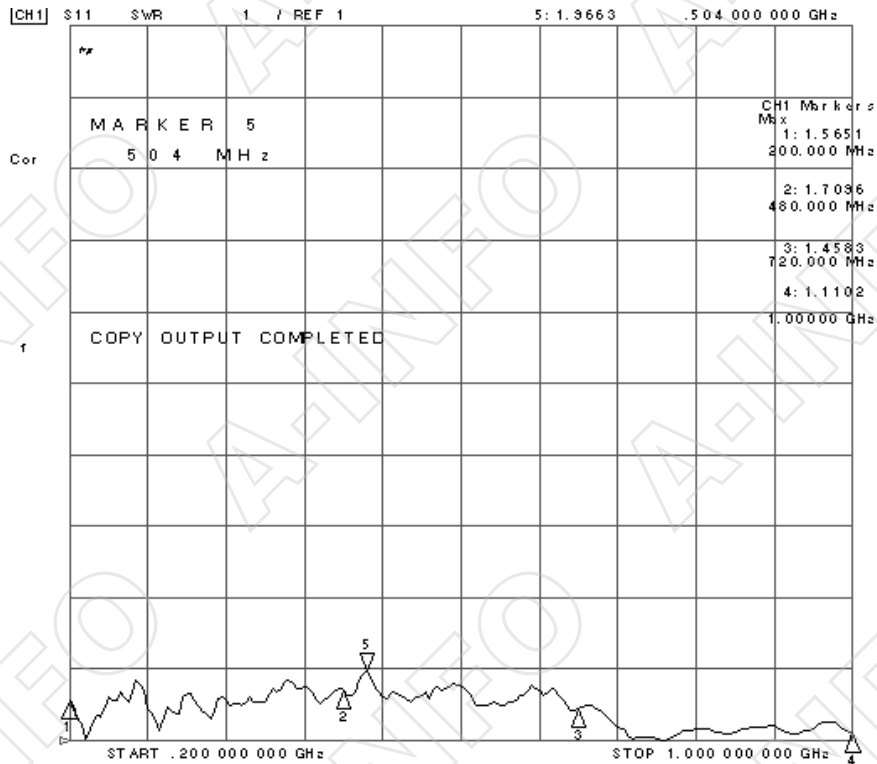

4. Cross Polarization Isolation

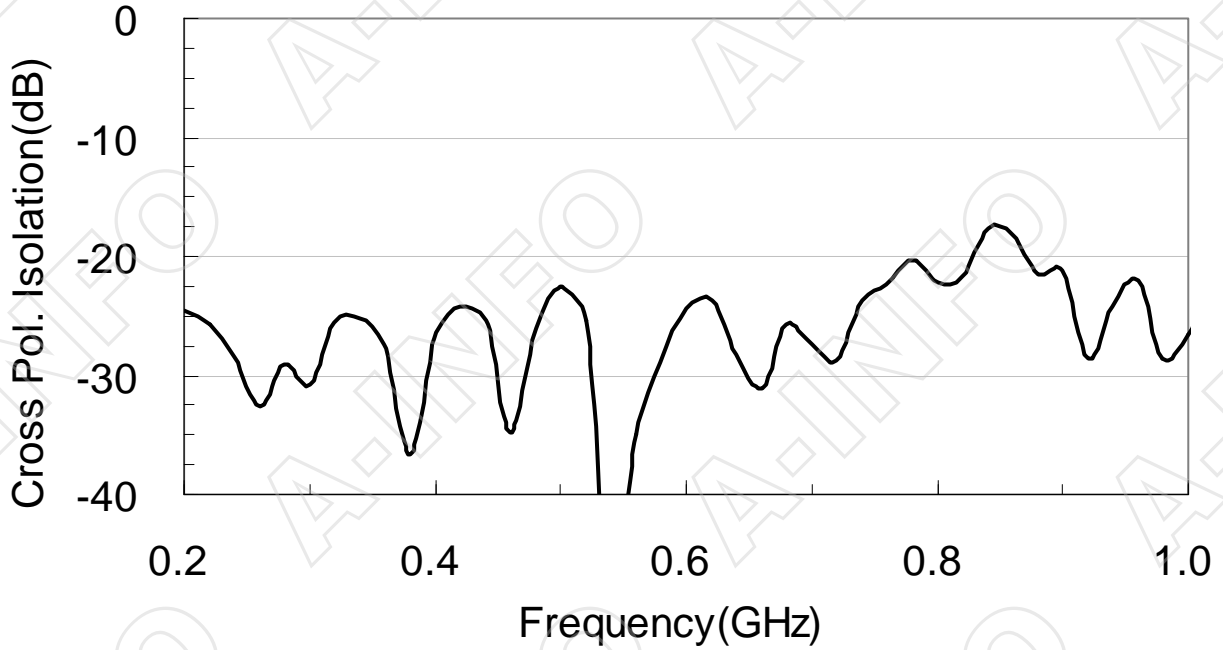

5. Port to Port Isolation

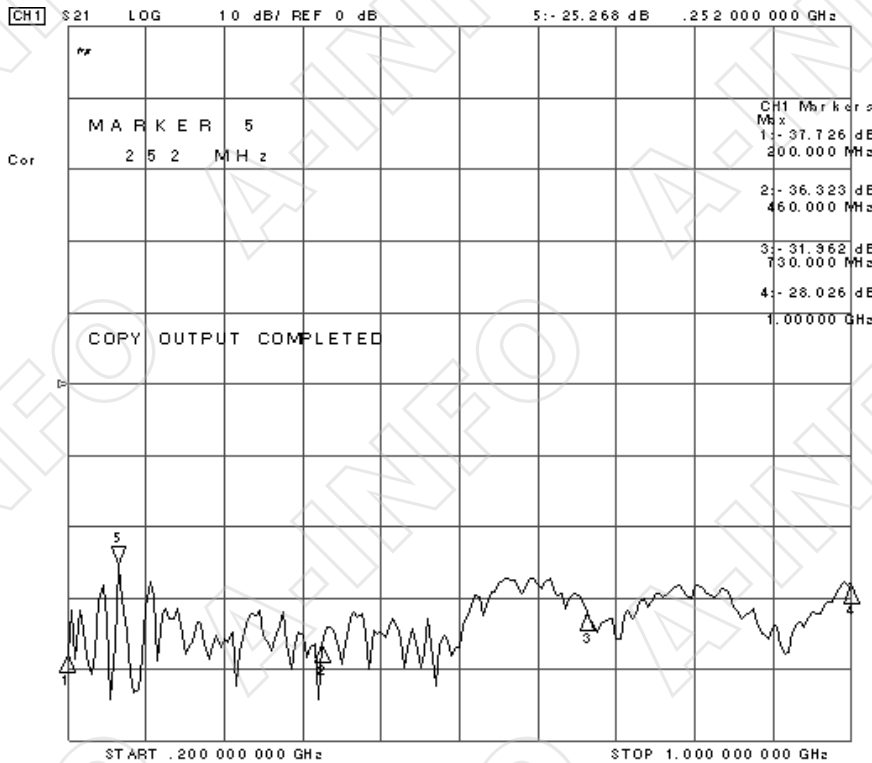

6. Pattern

Frequency: 0.2GHz

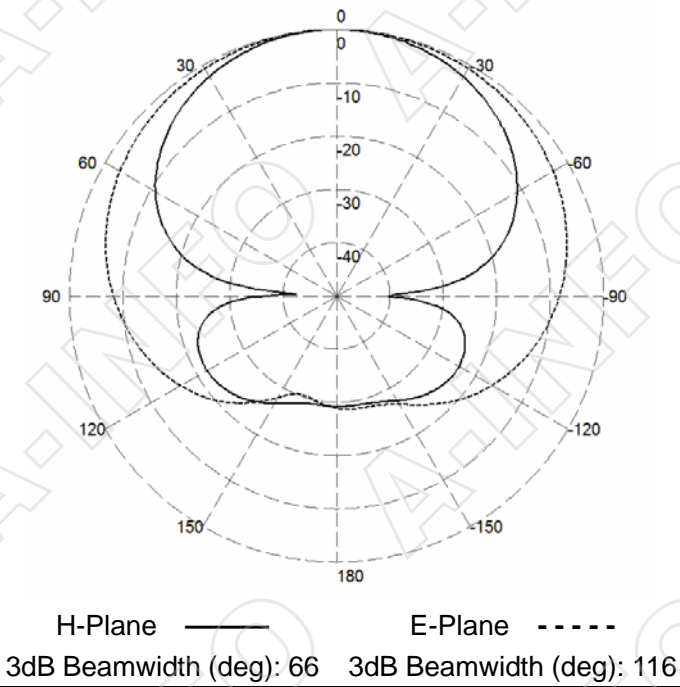

Frequency: 0.5GHz

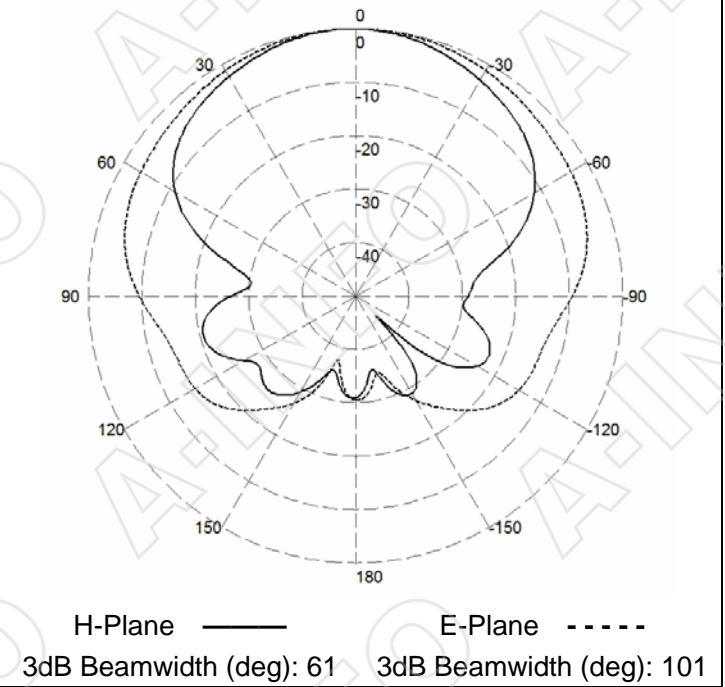

Frequency: 1.0GHz

