

Outline Drawing (Size: mm)

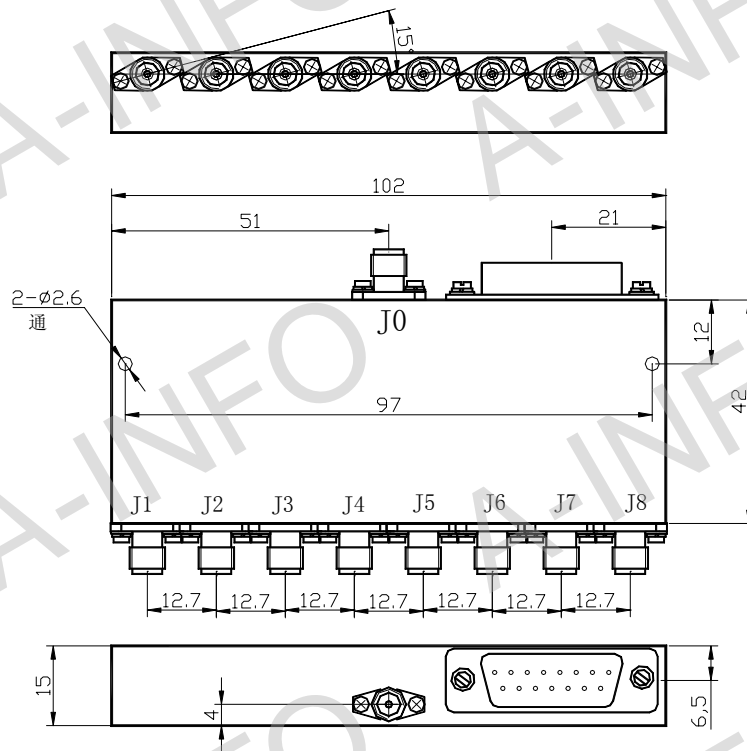

Technical Specification

Item	Technical Specification
Frequency Range(GHz)	12-18
Insertion Loss(dB)	5.0 max
Isolation(dB)	60 min
VSWR	2.0 max
Switching Speed(ns)	50
Power handling(W)	0.2
Connector	SMA -Female
Operating Temperature(°C)	-55 ~ +85
Storage Temperature(°C)	-65 ~ +125
Net Weight (Kg)	0.03 Around

Test Results

Isolation (J0-J1)

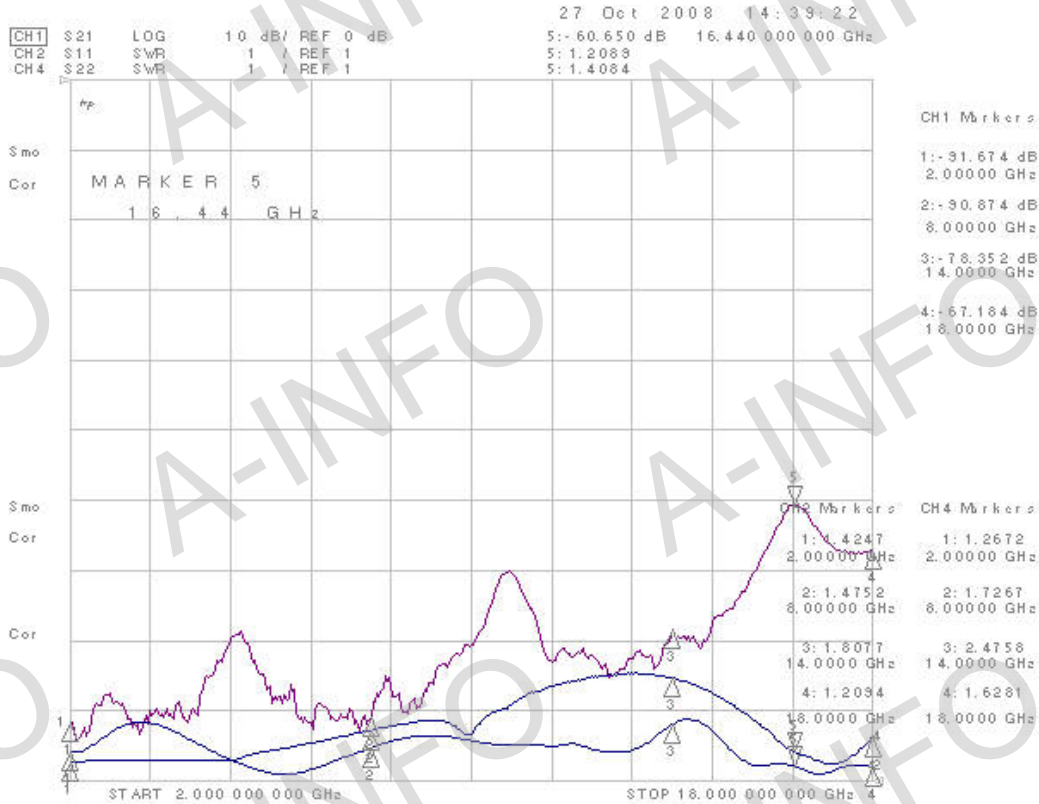

Insertion Loss & VSWR (J0-J2)

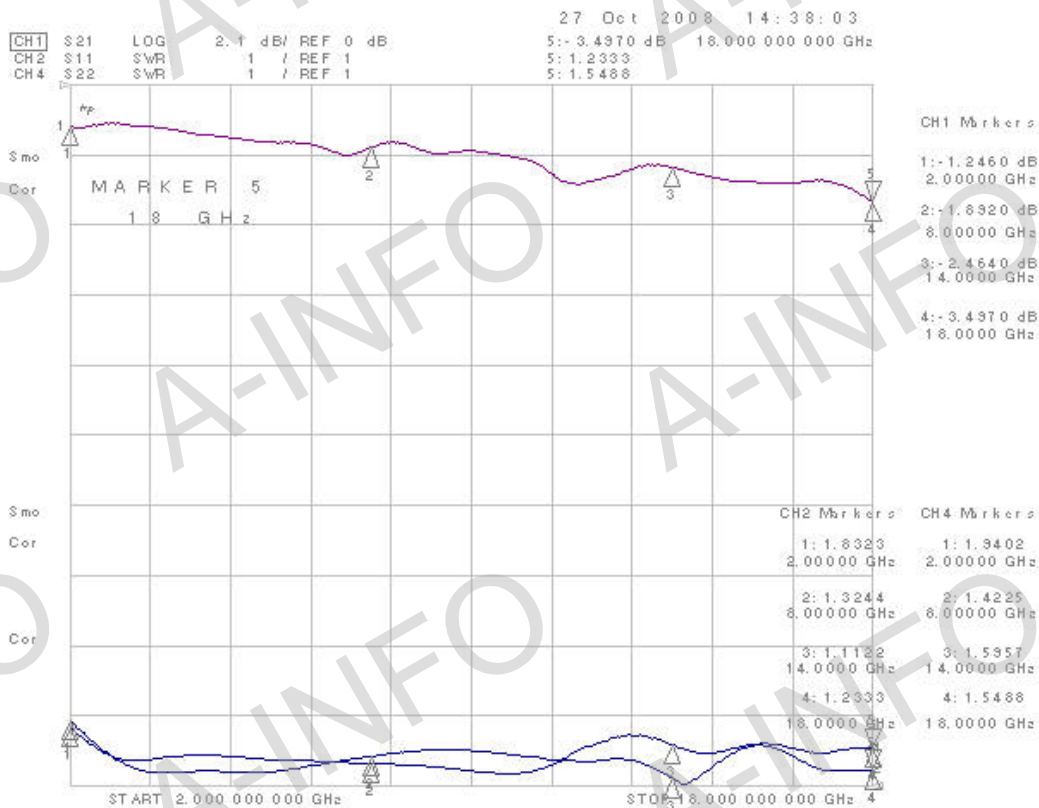

Isolation (J0-J2)

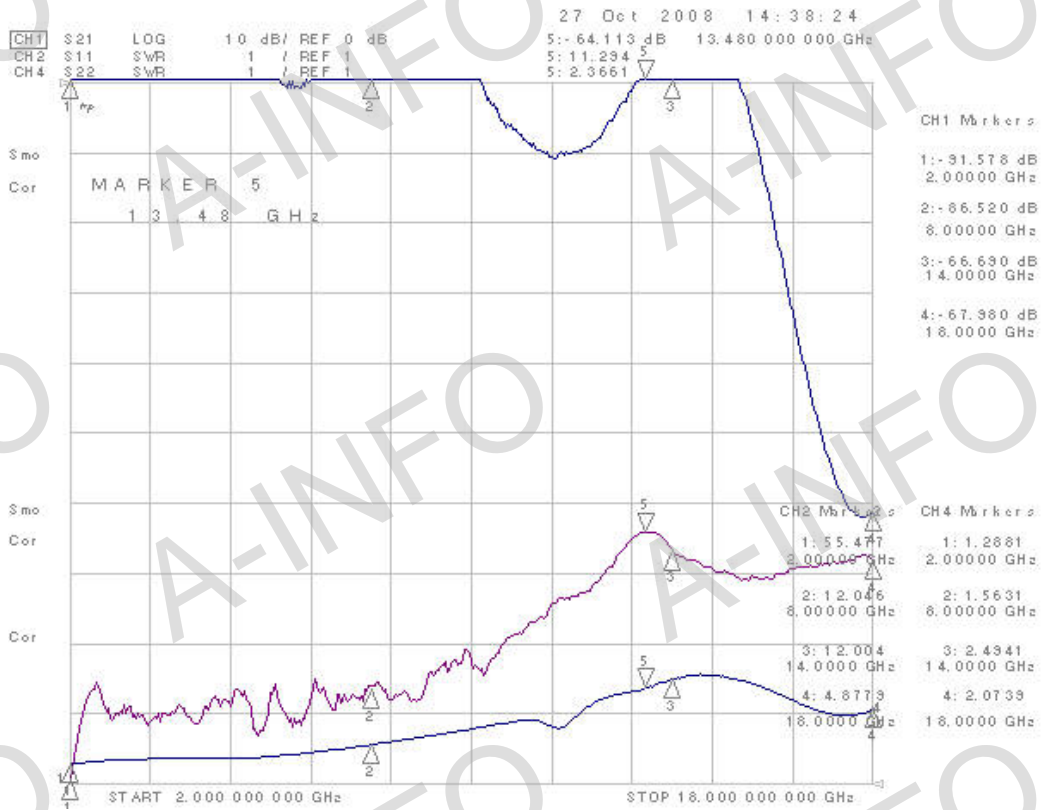

Insertion Loss & VSWR (J0-J3)

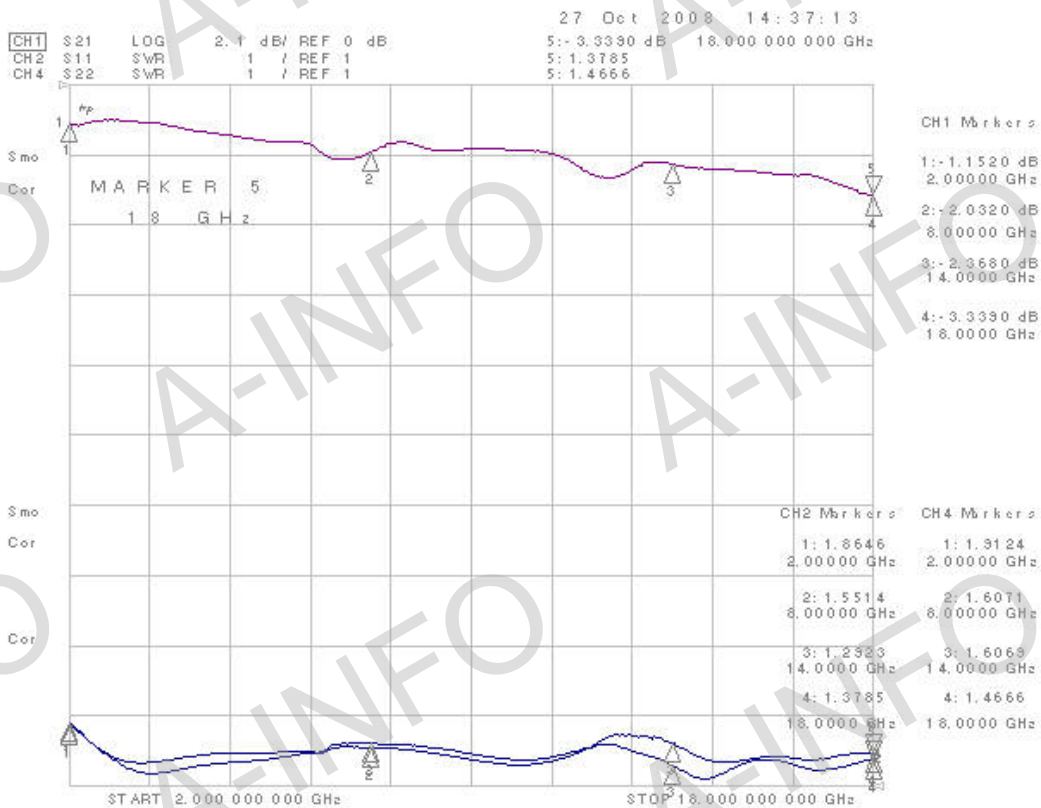

Isolation (J0-J3)

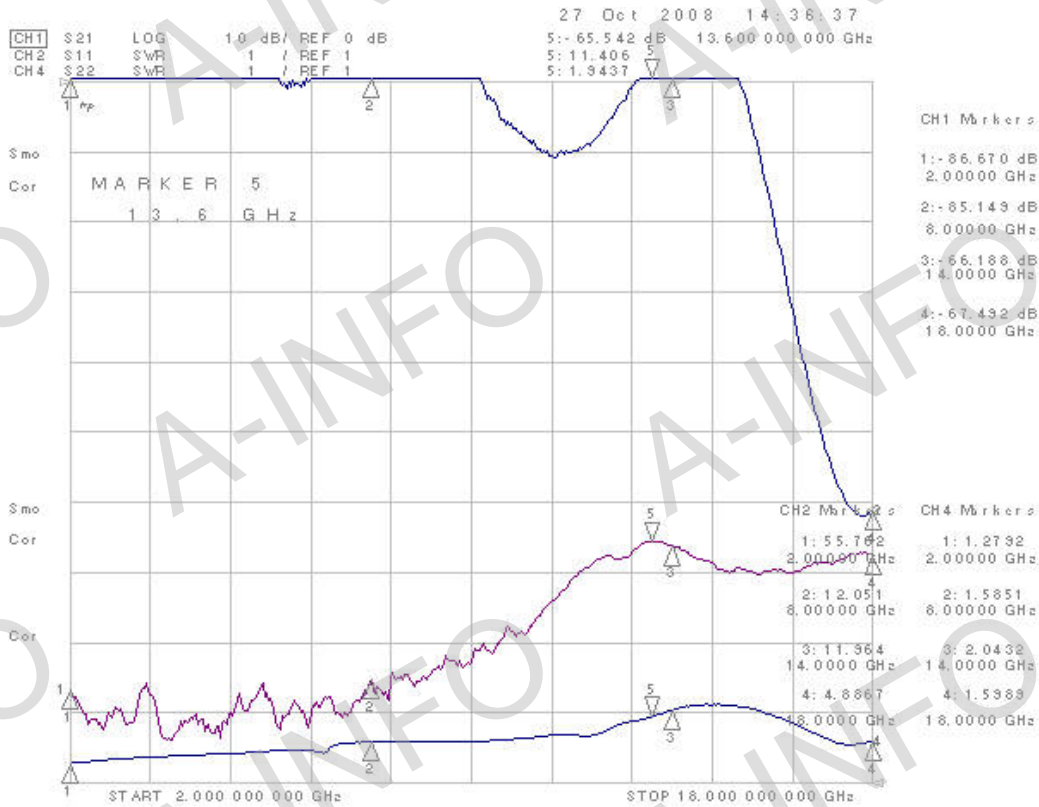

Insertion Loss & VSWR (J0-J4)

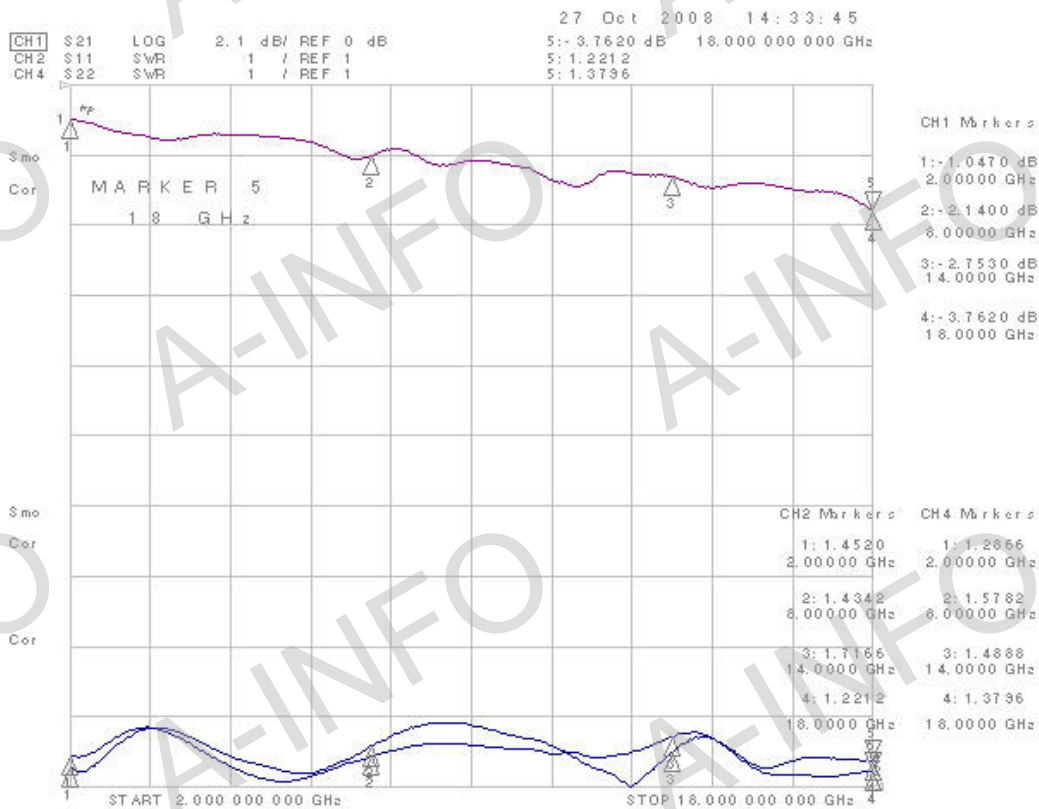

Isolation (J0-J4)

