

▪ **Outline Dimension Drawing**

Dimensions: mm[inch]

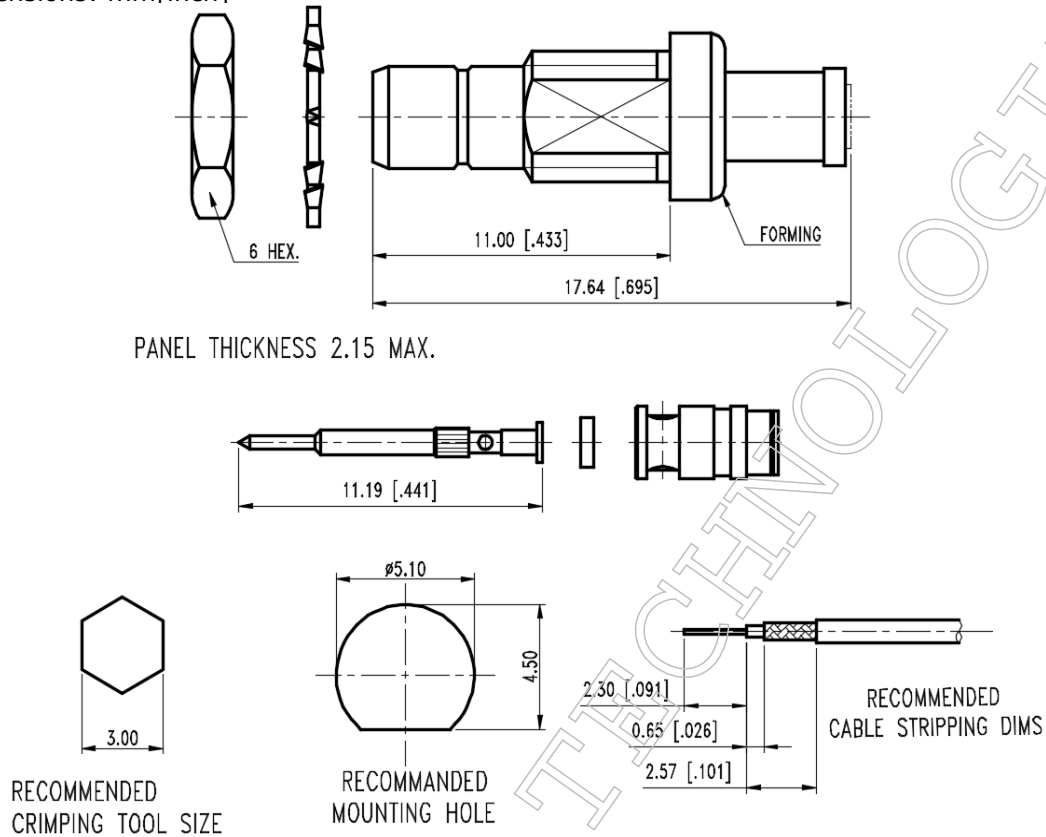

▪ **Material Specification**

Description	Material	Plating
Body*2	Brass	Gold
Pin	Brass	Gold
Dielectric*2	PTFE	
Ferrule	Brass	Gold
Nut	Brass	Gold
Washer	Brass	Gold

In the effort to improve our products, we reserve the right to make changes judged to be necessary



▪ **Electrical Specification**

Description			Description		
Impedance	50	Ω	Insulation Resistance	1000	MΩ Min.
Frequency	4	GHz	Inner Contact Resistance	5	mΩ Max.
VSWR	1.4	Max.	Outer Contact Resistance	2.5	mΩ Max.
Insertion Loss	0.12	dB Max.			
Voltage Rating	250	Vrms Max.			
Dielectric Withstanding Voltage	500	Vrms Max.			

▪ **Mechanical Specification**

Description			Description		
Center Contact			Recommended Torque	N/A	in. lbs
Axial Force-Mating End	N/A	lbs.	Engagement Force	14.0	lbs Max.
Axial Force-Opposite End	N/A	lbs.	Disengagement Force	4	lbs Min.
Connector Durability	500	cycles			
Weight	1.55	g			

▪ **Environmental Specification**

Description		
Temperature Min.	-65	°C
Temperature Max.	165	°C
Hermetic Seal	N/A	

In the effort to improve our products, we reserve the right to make changes judged to be necessary