

PRODUCT DATASHEET

Version 1.0

CGY2182UH/C1 3 – 10 GHz Double Balanced Mixer

DESCRIPTION

The CGY2182UH is a high performance GaAs based Double Balanced Mixer MMIC with on chip RF and LO baluns.

The CGY2182UH covers the frequency range of 3 GHz to 10 GHz with a conversion loss of typically 7 dB. On-chip baluns provide excellent rejection of LO to RF and IF paths. High dynamic range is provided by the passive mixer configuration. This device can be used in GPS, Telecommunication, Radar, EW and Instrumentation applications.

The die is manufactured using OMMIC's 0.18 μm gate length PHEMT Technology. The MMIC uses gold bonding pads and backside metallization and is fully protected with Silicon Nitride passivation to obtain the highest level of reliability. This technology has been evaluated for Space applications and is on the European Preferred Parts List of the European Space Agency.

APPLICATIONS

- ▶ GPS Systems
- ▶ Radar
- ▶ Telecommunication
- ▶ Instrumentation



FEATURES

- ▶ RF and LO Range : 3 GHz to 10 GHz
- ▶ IF Range : DC – 3 GHz
- ▶ Conversion Loss : 7 dB
- ▶ LO to RF Isolation : 60 dB
- ▶ LO to IF Isolation : 45 dB
- ▶ Input P1dB : 12 dBm
- ▶ Small Chip Size 1.5 mm x 1.5 mm
- ▶ Tested, Inspected Known Good Die (KGD)
- ▶ Samples available
- ▶ Demonstration Boards available
- ▶ Space and MIL-STD also available

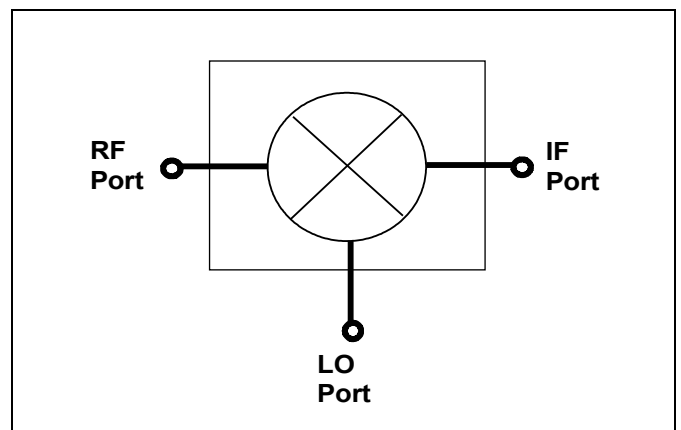

Block Diagram of the Mixer

LIMITING VALUES

$T_{amb} = 25\text{ }^{\circ}\text{C}$ unless otherwise noted

| Symbol | Parameter | Conditions | MIN. | MAX. | UNIT |
|-----------|------------------------------|------------|------|-------|--------------------|
| P_{LO} | Local Oscillator Input Power | | | +17.5 | dBm |
| P_{RF} | RF Input Power | | | +15 | dBm |
| P_{IF} | IF Input Power | | | +15 | dBm |
| T_{amb} | Ambient temperature | | -40 | +85 | $^{\circ}\text{C}$ |
| T_j | Junction temperature | | | +150 | $^{\circ}\text{C}$ |
| T_{stg} | Storage temperature | | -55 | +150 | $^{\circ}\text{C}$ |

THERMAL CHARACTERISTICS

| Symbol | Parameter | Value | UNIT |
|---------------|--|-------|----------------------|
| $R_{th(j-a)}$ | Thermal resistance from junction to ambient ($T_a = 25\text{ }^{\circ}\text{C}$) | TBD | $^{\circ}\text{C/W}$ |

CHARACTERISTICS

$T_{amb} = 25\text{ }^{\circ}\text{C}$ – RF Performance measured on wafer.

| Symbol | Parameter | Conditions | MIN. | TYP. | MAX. | UNIT |
|--|-----------------------------|-------------------|------|------|------|------|
| <i>Unless otherwise specified LO Power = + 15 dBm; IF = 100 MHz; Down Converter Mode</i> | | | | | | |
| BW_{RF} | RF Bandwidth | | 3 | | 10 | GHz |
| BW_{LO} | LO Bandwidth | | 3 | | 10 | GHz |
| BW_{IF} | IF Bandwidth | | DC | | 3 | GHz |
| G_c | Conversion Loss | | | 7 | 10 | dB |
| NF (SSB) | SSB Noise Figure | | | 7 | | dB |
| ISO_{LO-RF} | LO to RF Isolation | Up Converter Mode | | 60 | | dB |
| ISO_{LO-IF} | LO to IF Isolation | | | 45 | | dB |
| P_{1dB} | Input 1dB Compression Point | | | 12 | | dBm |



Caution : This device is a high performance RF component and can be damaged by inappropriate handling. Standard ESD precautions should be followed. OMMIC document “OM-CI-MV/ 001/ PG” contains more information on the precautions to take.

ON WAFER MEASUREMENTS – CONVERSION LOSSES

1 - Down converter Mode :

$P_{LO} = 15 \text{ dBm}$
 $P_{RF} = -15 \text{ dBm}$
 $F_{IF} = 0.1 \text{ GHz}$
 $NH_{RF} = 4$
 $NH_{LO} = 8$
 $F_{LO} = \text{sweep}$

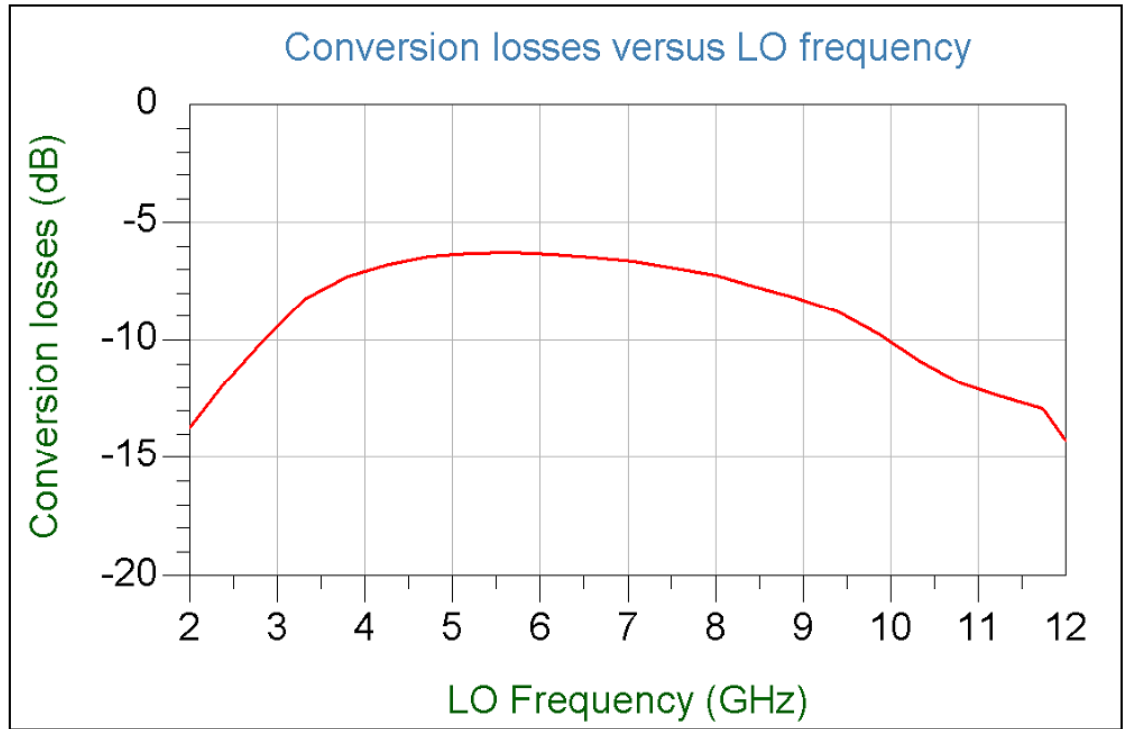

$P_{LO} = 15 \text{ dBm}$
 $P_{RF} = -15 \text{ dBm}$
 $NH_{RF} = 4$
 $NH_{LO} = 8$
 $F_{LO} = \text{sweep}$
 $F_{IF} = \text{param}$

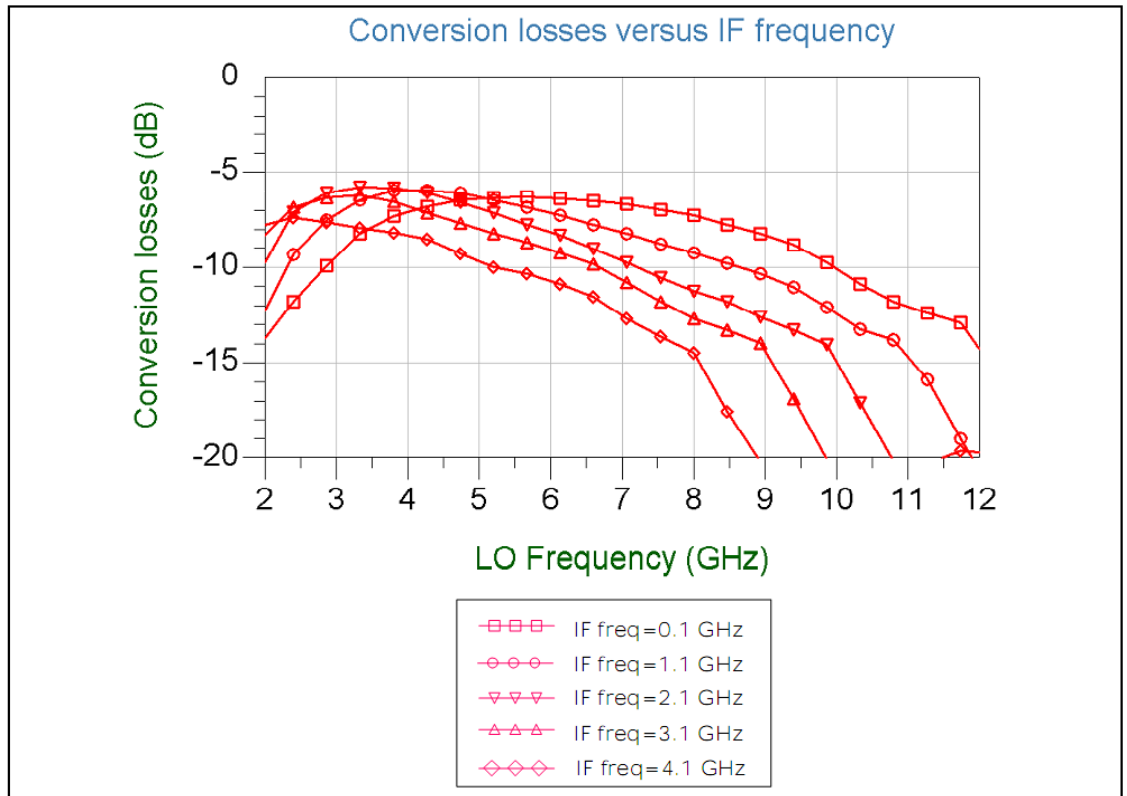

ON WAFER MEASUREMENTS – CONVERSION LOSSES

$P_{LO} = 15 \text{ dBm}$
 $P_{RF} = -15 \text{ dBm}$
 $F_{IF} = 0.1 \text{ GHz}$
 $NH_{RF} = 4$
 $NH_{LO} = 8$
 $F_{LO} = \text{sweep}$
 $T^\circ = \text{param}$

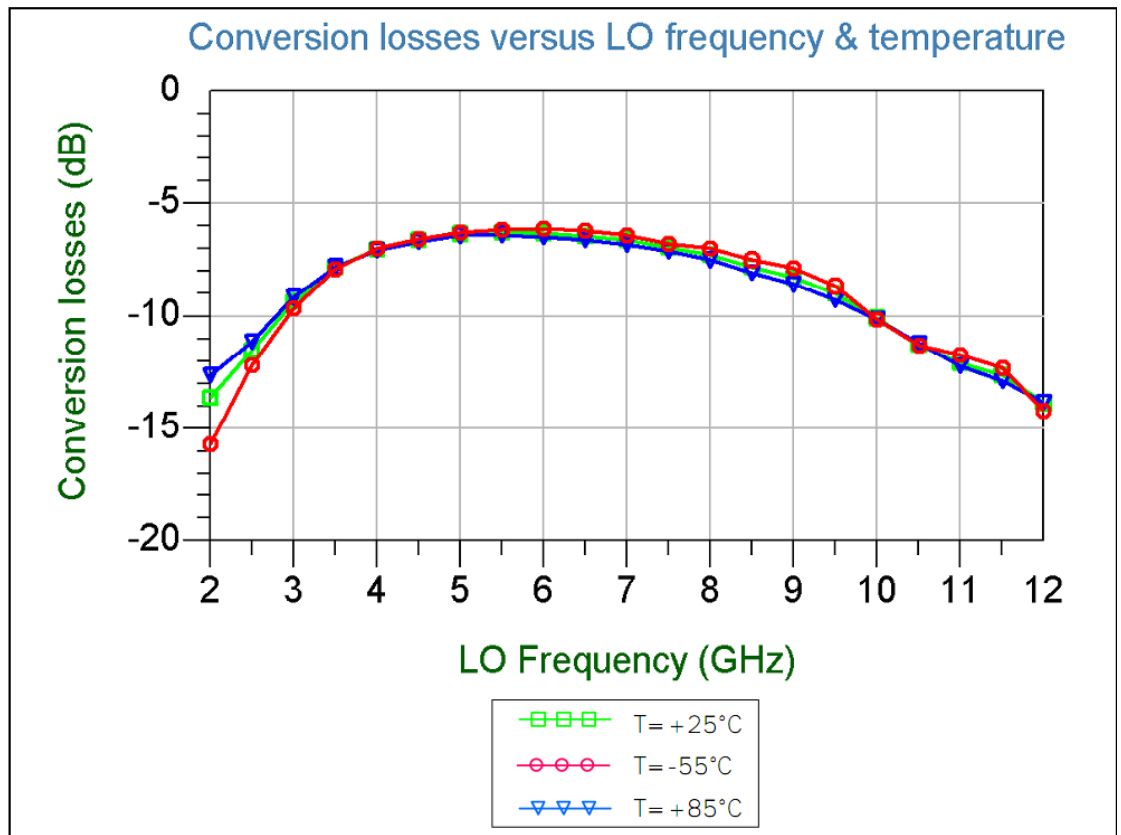

$P_{RF} = -15 \text{ dBm}$
 $F_{IF} = 0.1 \text{ GHz}$
 $NH_{RF} = 4$
 $NH_{LO} = 8$
 $F_{LO} = \text{sweep}$
 $P_{LO} = \text{param}$

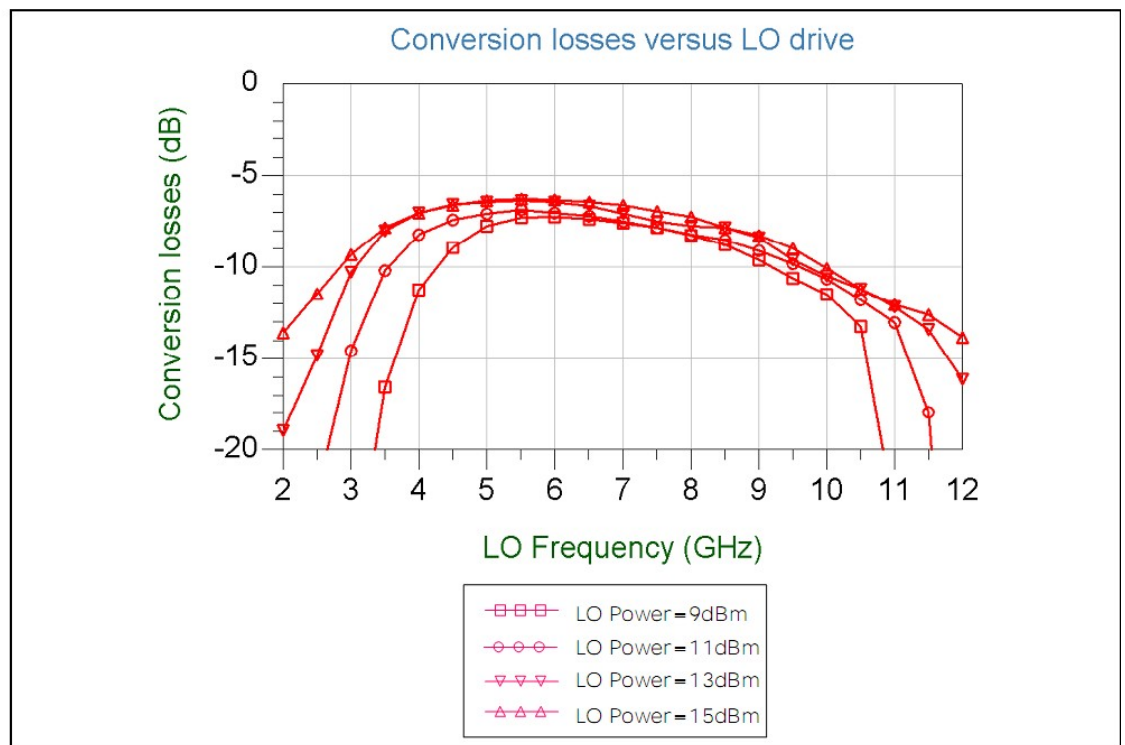

ON WAFER MEASUREMENTS – CONVERSION LOSSES

2 – Up Converter Mode :

$P_{LO} = 15 \text{ dBm}$
 $P_{IF} = -15 \text{ dBm}$
 $F_{IF} = 0.1 \text{ GHz}$
 $NH_{IF} = 4$
 $NH_{LO} = 8$
 $F_{LO} = \text{sweep}$

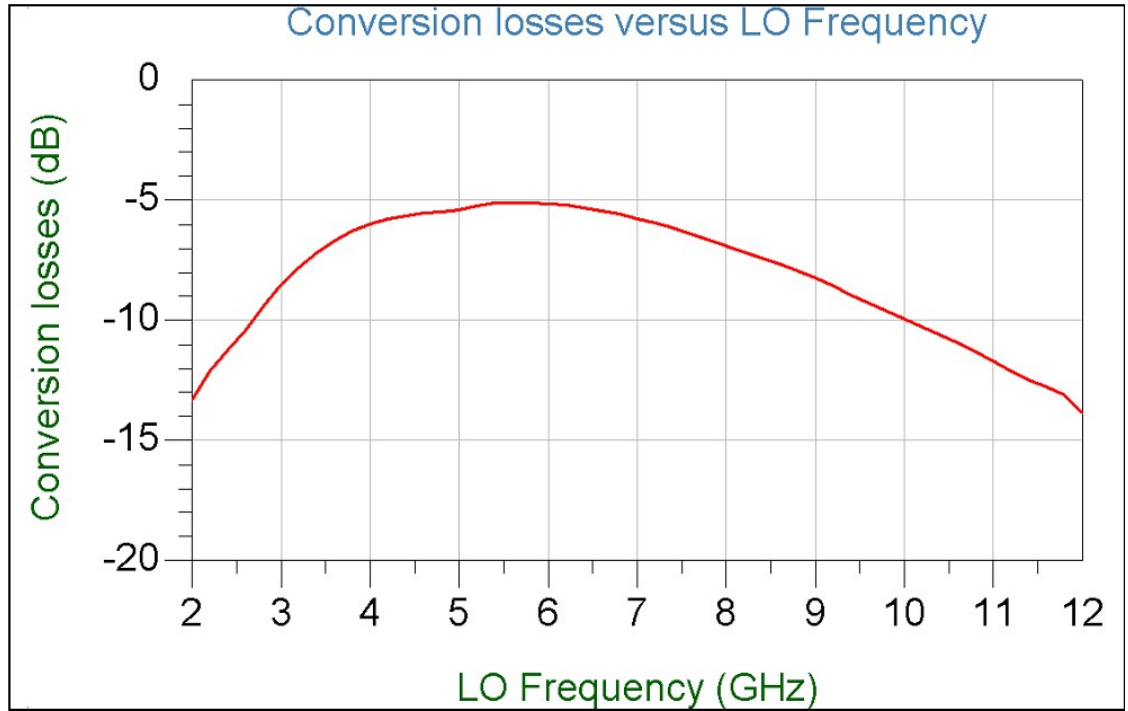

$P_{LO} = 15 \text{ dBm}$
 $P_{IF} = -15 \text{ dBm}$
 $NH_{IF} = 4$
 $NH_{LO} = 8$
 $F_{LO} = \text{sweep}$
 $F_{IF} = \text{param}$

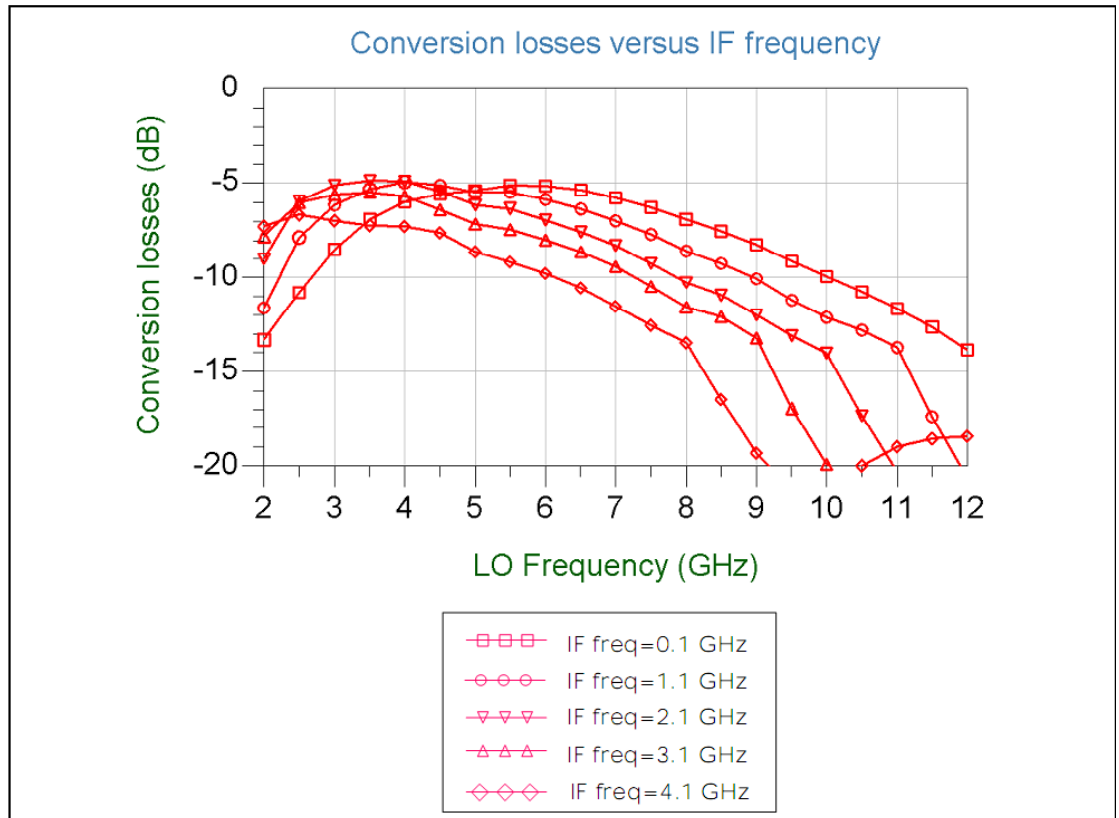

ON WAFER MEASUREMENTS – CONVERSION LOSSES

$P_{LO} = 15 \text{ dBm}$
 $P_{IF} = -15 \text{ dBm}$
 $F_{IF} = 0.1 \text{ GHz}$
 $NH_{IF} = 4$
 $NH_{LO} = 8$
 $F_{LO} = \text{sweep}$
 $T^\circ = \text{param}$

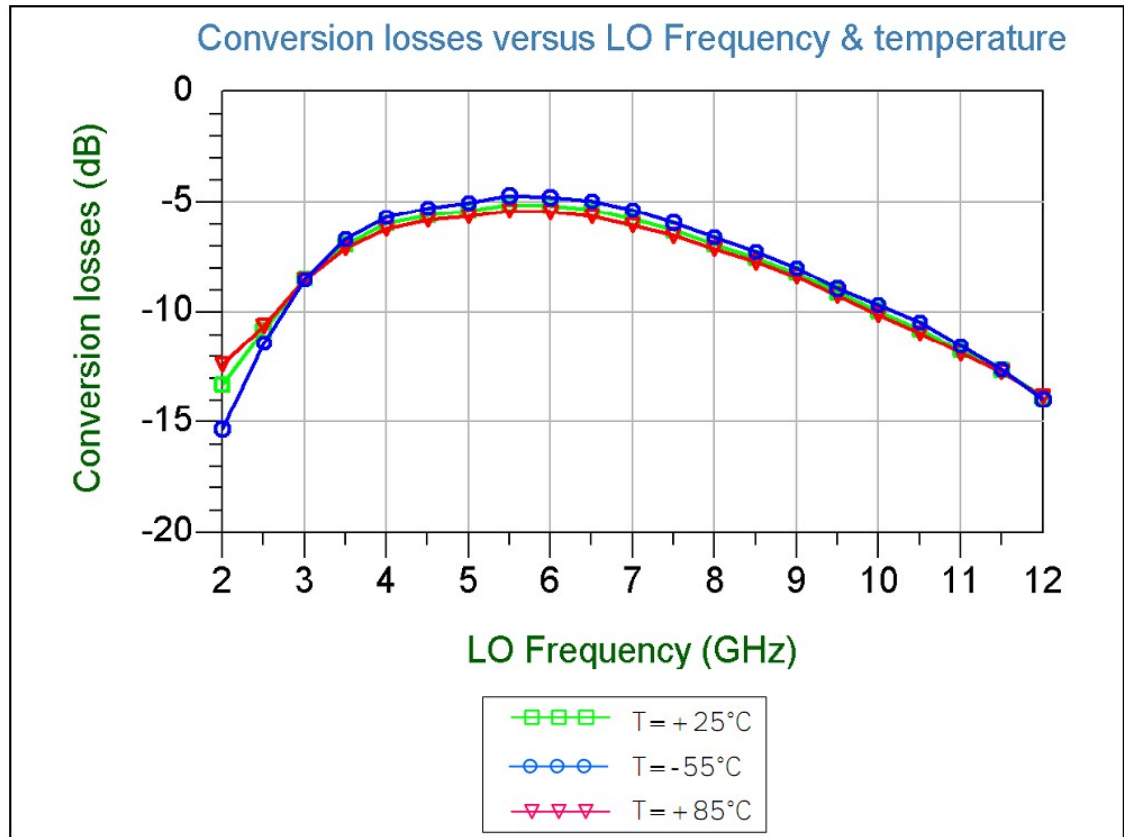

$P_{IF} = -15 \text{ dBm}$
 $F_{IF} = 0.1 \text{ GHz}$
 $NH_{IF} = 4$
 $NH_{LO} = 8$
 $F_{LO} = \text{sweep}$
 $P_{LO} = \text{param}$

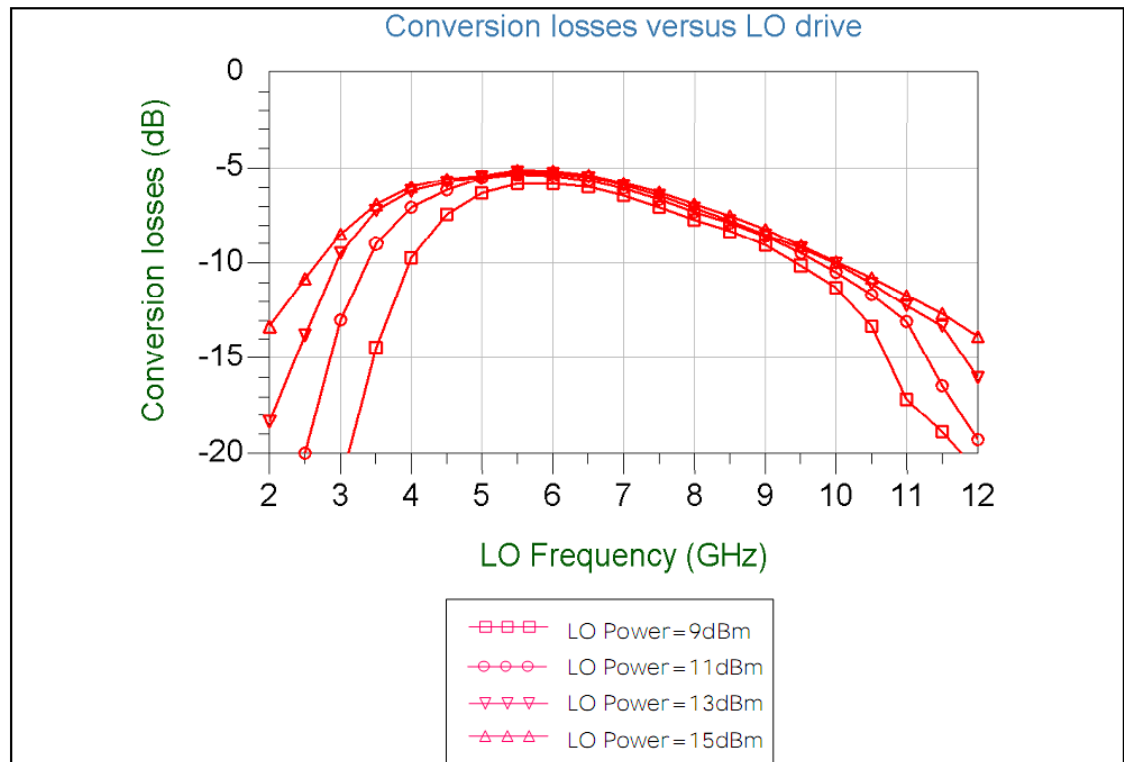

ON WAFER MEASUREMENTS – ISOLATIONS

1- Down converter Mode :

$P_{LO} = 15 \text{ dBm}$
 $P_{RF} = -15 \text{ dBm}$
 $F_{IF} = 0.1 \text{ GHz}$
 $NH_{RF} = 4$
 $NH_{LO} = 8$
 $F_{LO} = \text{sweep}$

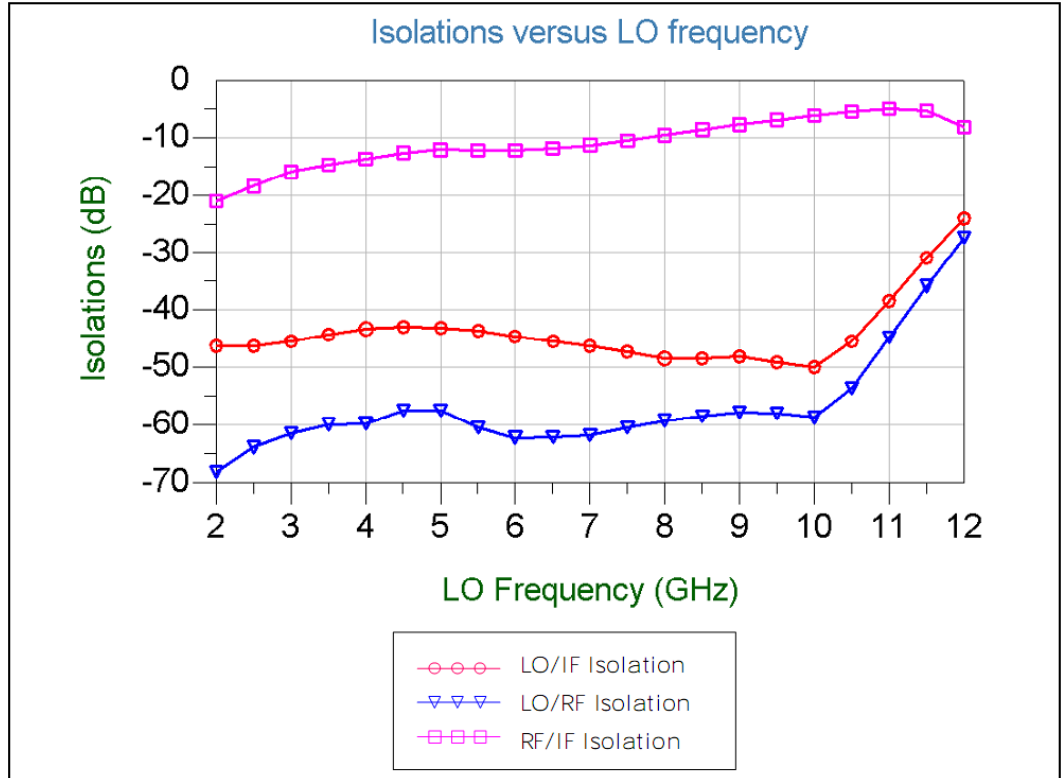

2 – Up Converter Mode :

$P_{LO} = 15 \text{ dBm}$
 $P_{IF} = -15 \text{ dBm}$
 $F_{IF} = 0.1 \text{ GHz}$
 $NH_{IF} = 4$
 $NH_{LO} = 8$
 $F_{LO} = \text{sweep}$

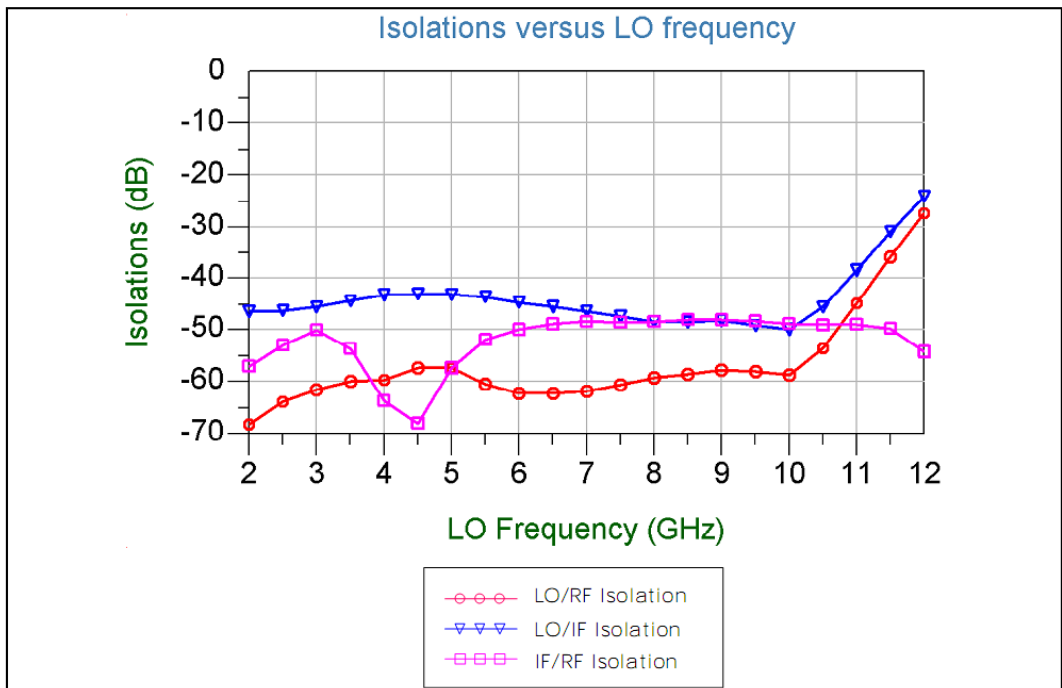

ON WAFER MEASUREMENTS – INPUT/OUTPUT RETURN LOSS

Up or Down converter Mode.

$P_{LO} = 15 \text{ dBm}$
 $P_{RF} = -40 \text{ dBm}$
 $NH_{RF} = 4$
 $NH_{LO} = 8$
 $F_{RF} = \text{sweep}$
 $F_{LO} = \text{param}$

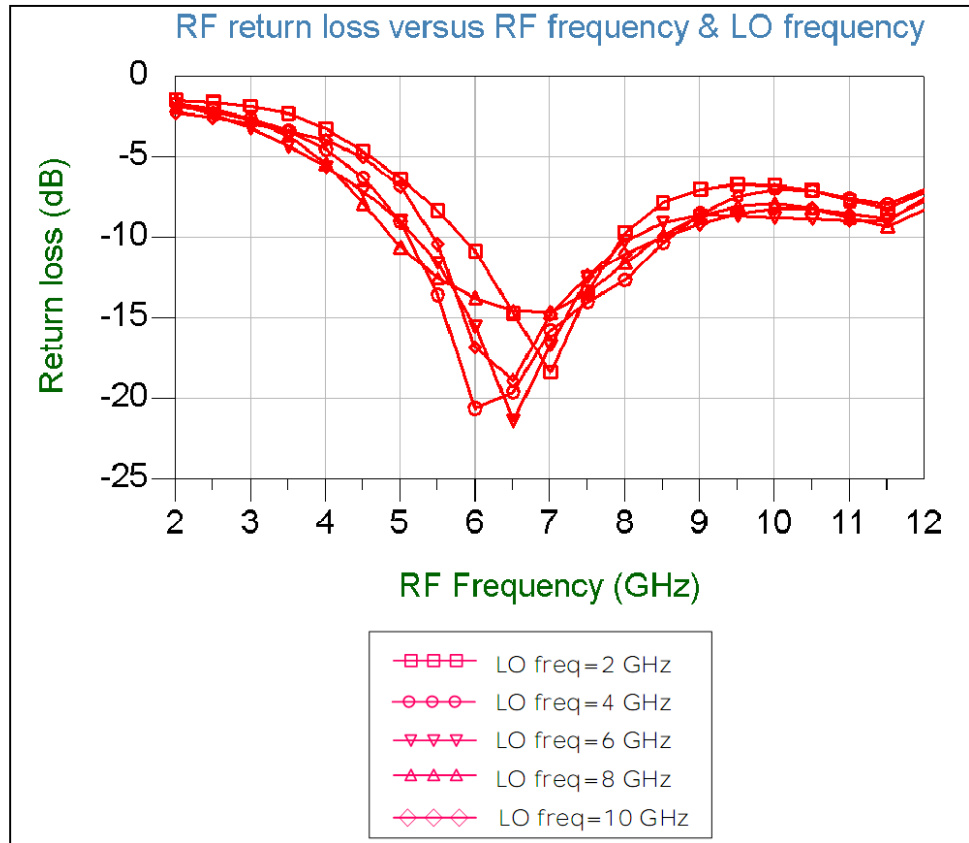

$P_{LO} = 15 \text{ dBm}$
 $P_{RF} = -15 \text{ dBm}$
 $F_{IF} = 0.1 \text{ GHz}$
 $NH_{RF} = 4$
 $NH_{LO} = 8$
 $F_{LO} = \text{sweep}$

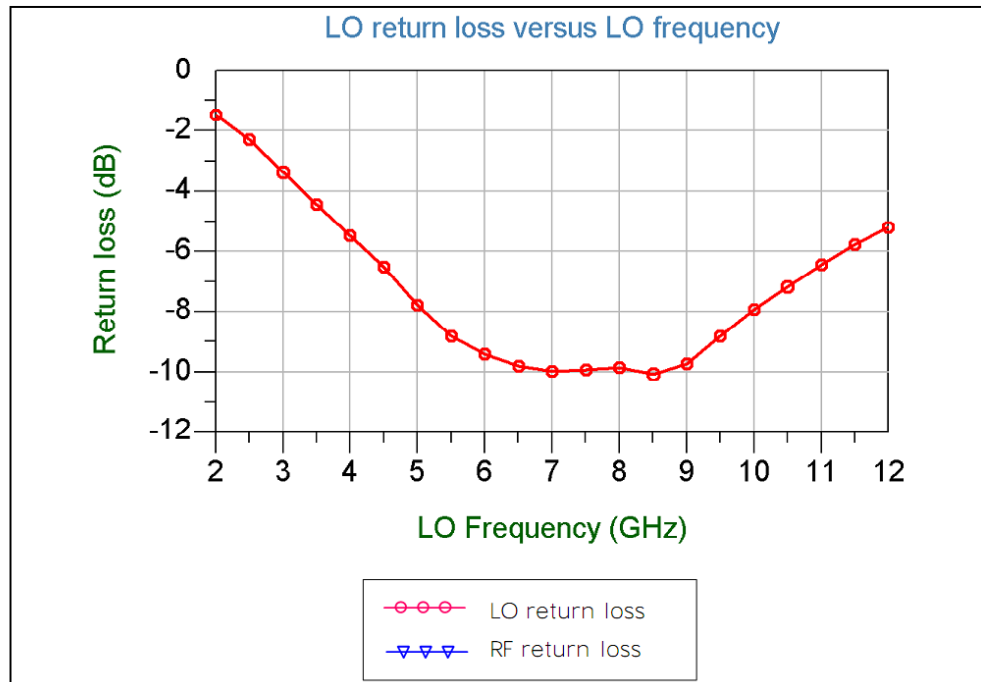

ON WAFER MEASUREMENTS – INPUT/OUTPUT RETURN LOSS

Up or Down converter Mode.

$P_{LO} = 15 \text{ dBm}$
 $P_{IF} = -40 \text{ dBm}$
 $NH_{IF} = 4$
 $NH_{LO} = 8$
 $F_{IF} = \text{sweep}$
 $F_{LO} = \text{param}$

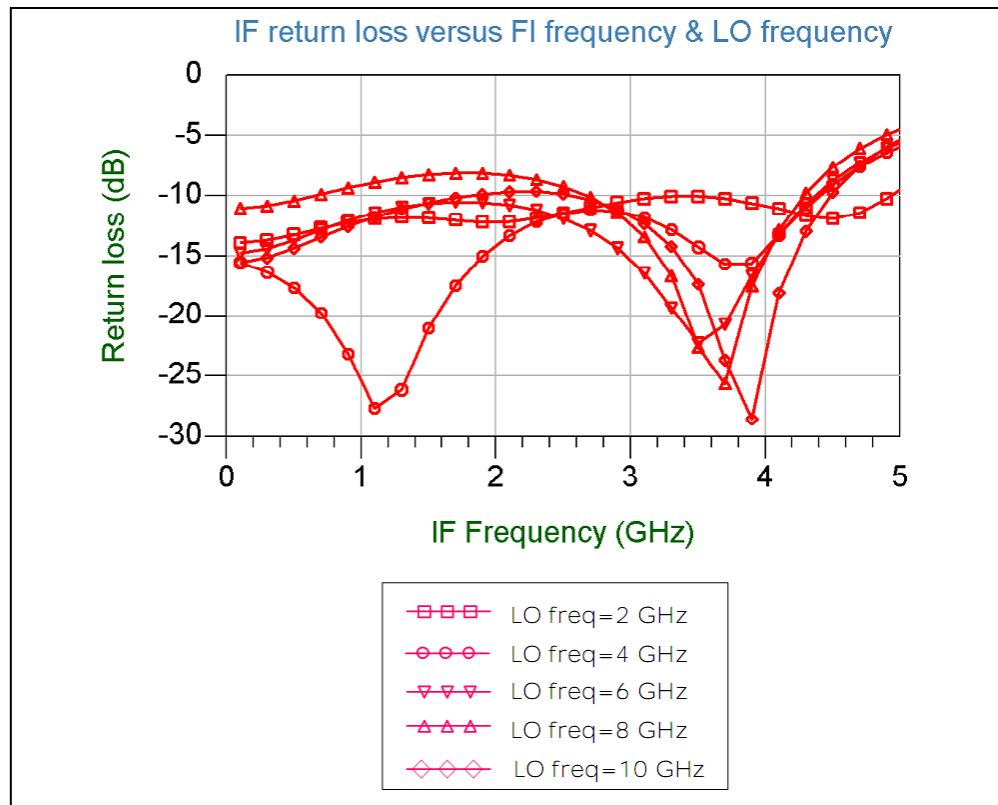

ON WAFER MEASUREMENTS – INPUT & OUTPUT P1DB

1 – Down converter mode :

$F_{IF} = 0.1$ GHz
 $NH_{RF} = 4$
 $NH_{LO} = 8$
 $F_{LO} = \text{sweep}$
 $P_{LO} = \text{param}$

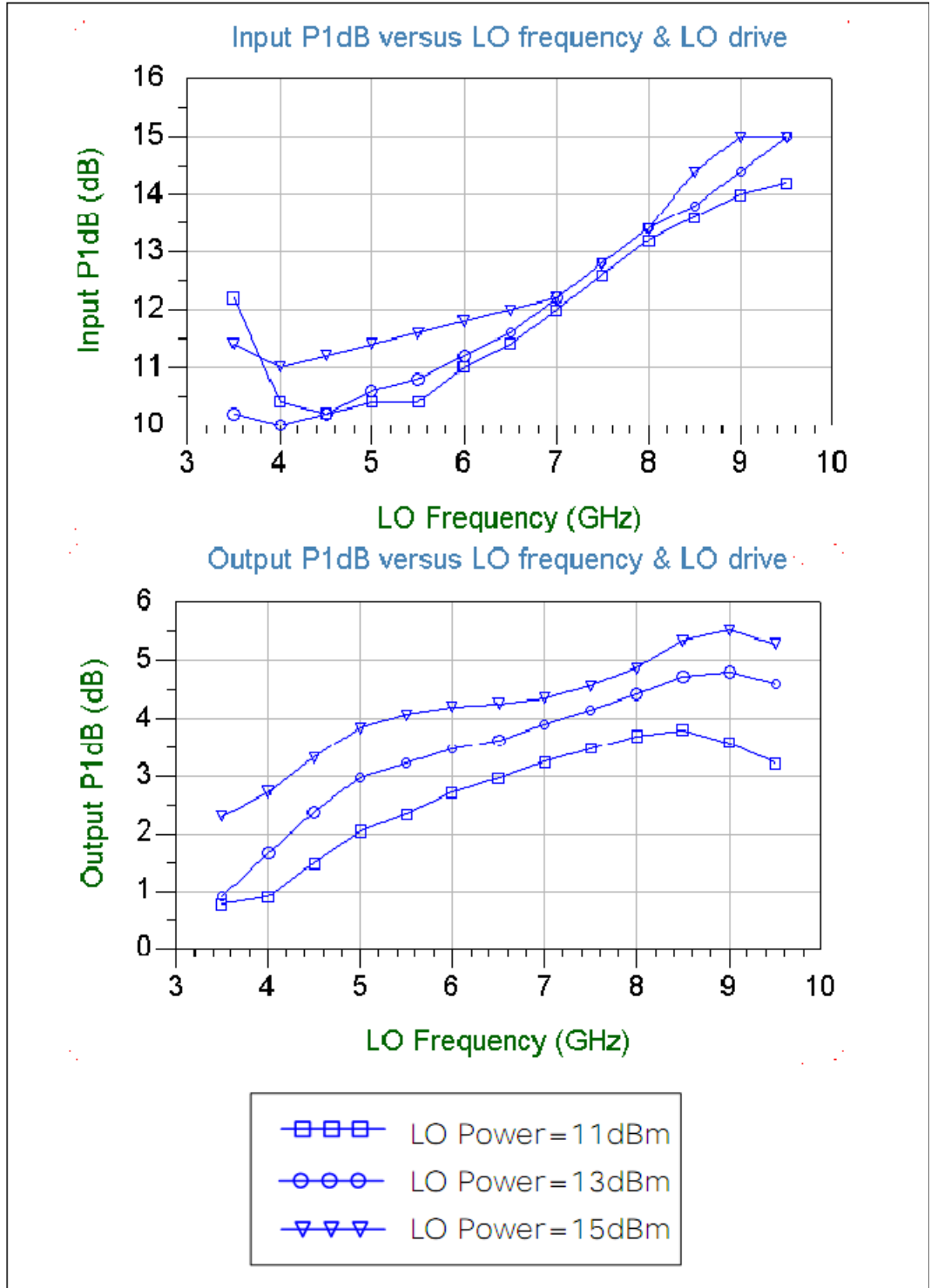

ON WAFER MEASUREMENTS – INPUT & OUTPUT P1DB

2 – Up converter mode :

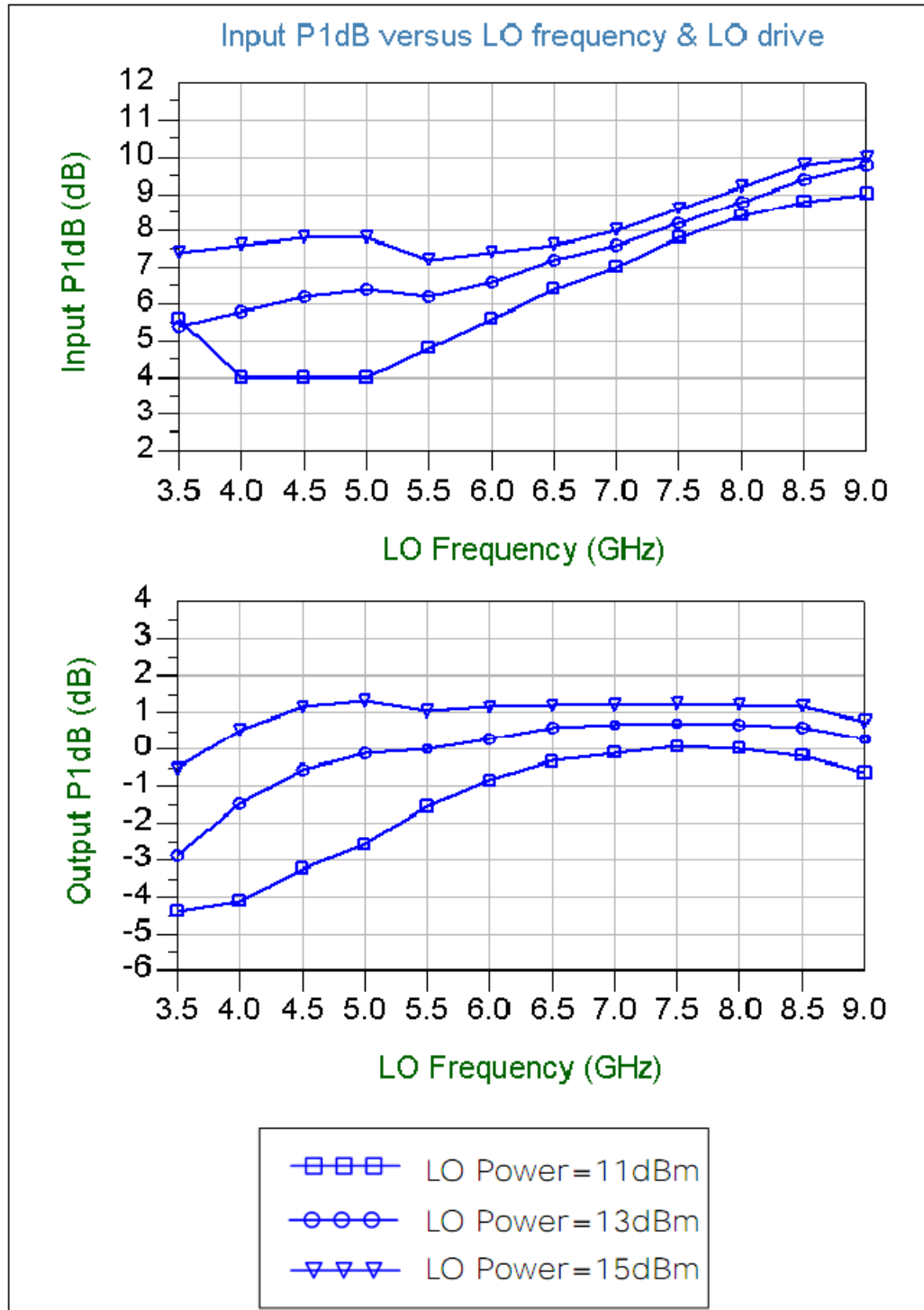

$F_{IF} = 0.1$ GHz

$NH_{IF} = 4$

$NH_{LO} = 8$

$F_{LO} = \text{sweep}$

$P_{LO} = \text{param}$

ON WAFER MEASUREMENTS – LO HARMONICS

1 – Down converter mode :

$P_{LO} = 13$ dBm
 $P_{RF} = -10$ dBm
 $F_{IF} = 0.1$ GHz
 $NH_{RF} = 4$
 $NH_{LO} = 8$
 $F_{LO} = \text{sweep}$

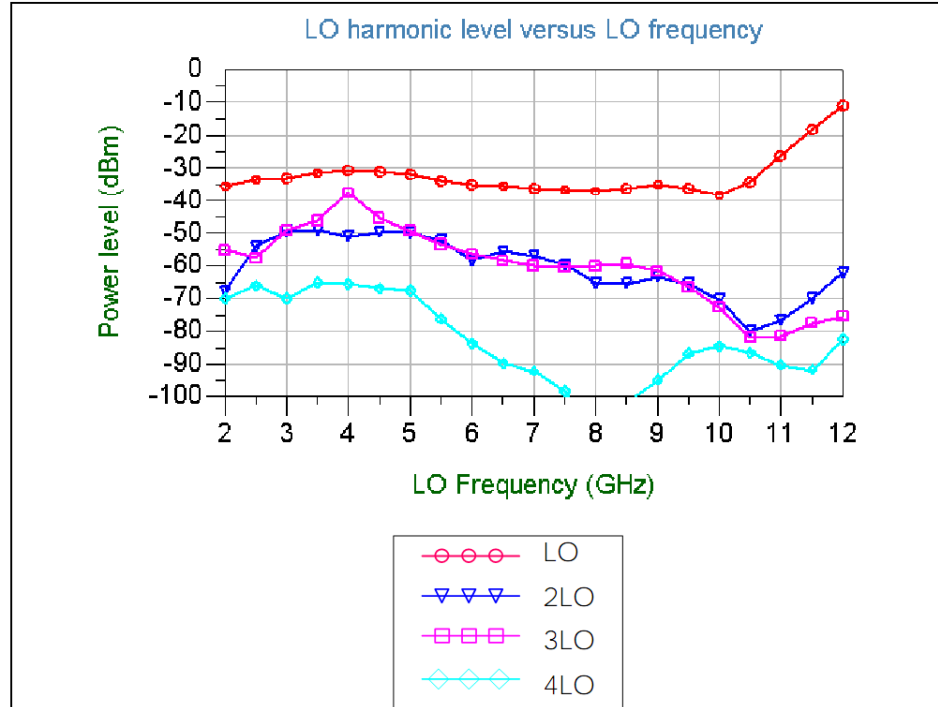

2 – Up converter mode :

$P_{LO} = 13$ dBm
 $P_{IF} = -10$ dBm
 $F_{IF} = 0.1$ GHz
 $NH_{IF} = 4$
 $NH_{LO} = 8$
 $F_{LO} = \text{sweep}$

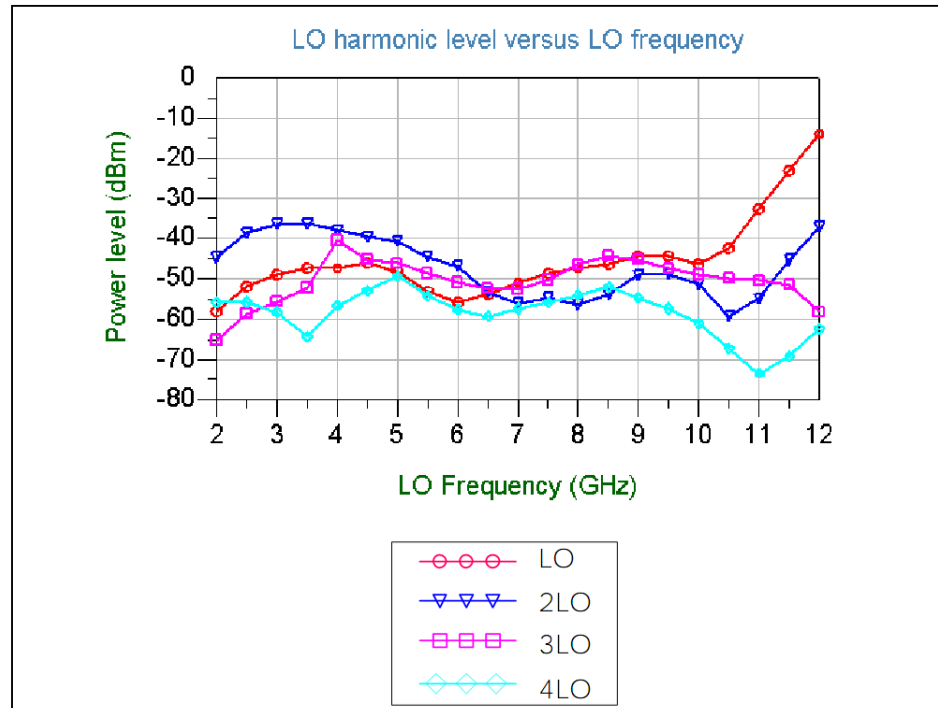

MECHANICAL INFORMATION

| | |
|--------------------------|--|
| Chip size: | 1465 μm x 1465 μm (after wafer sawing) |
| Substrate thickness: | 100 μm |
| Back-side metallization: | YES |
| Use of via-holes: | YES |
| RF pads size: | 100 x 100 μm |

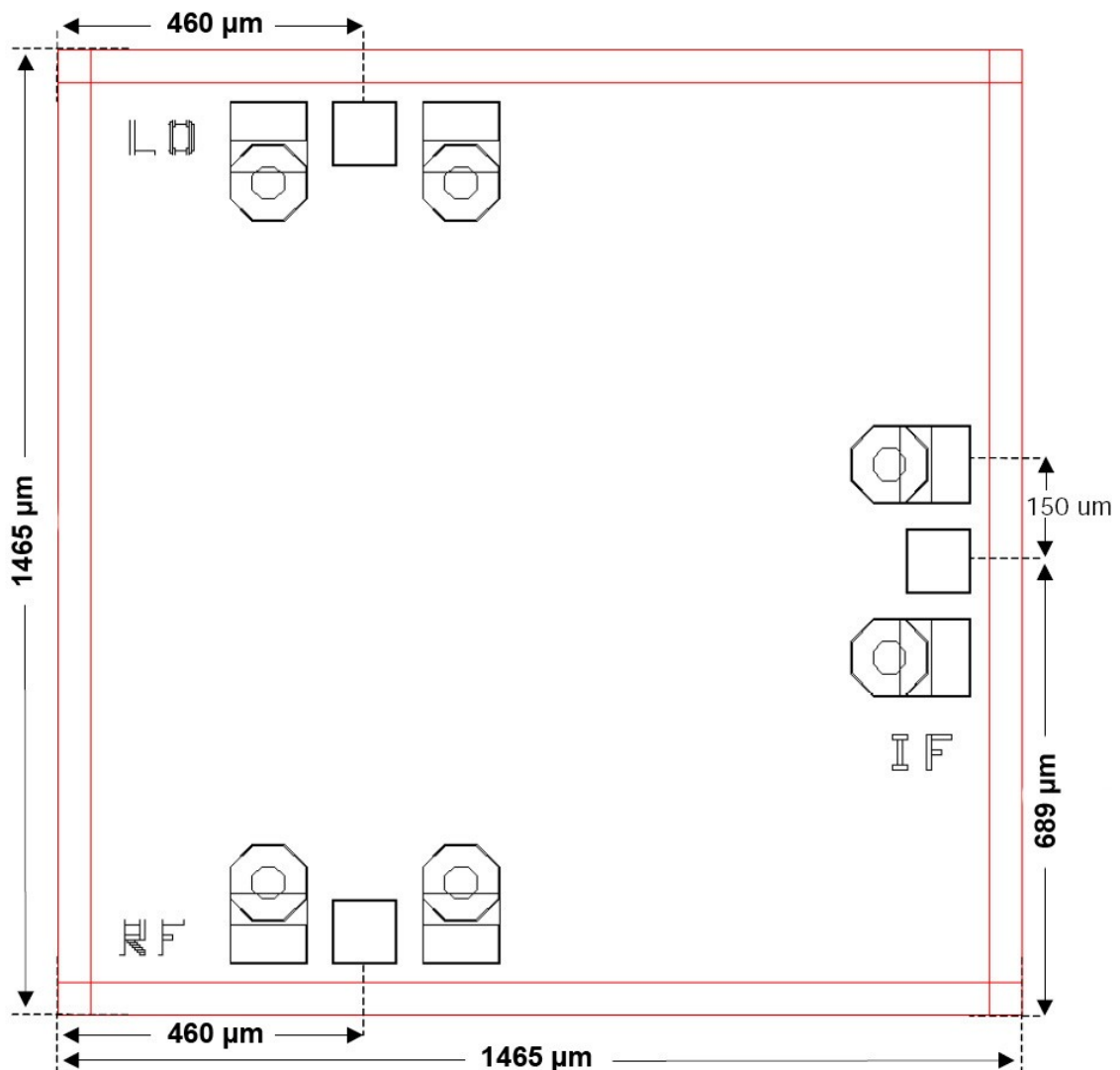

Caution : This device is a high performance RF component and can be damaged by inappropriate handling. Standard ESD precautions should be followed. OMMIC document "OM-CI-MV/ 001/ PG" contains more information on the precautions to take.

BLOCK DIAGRAM

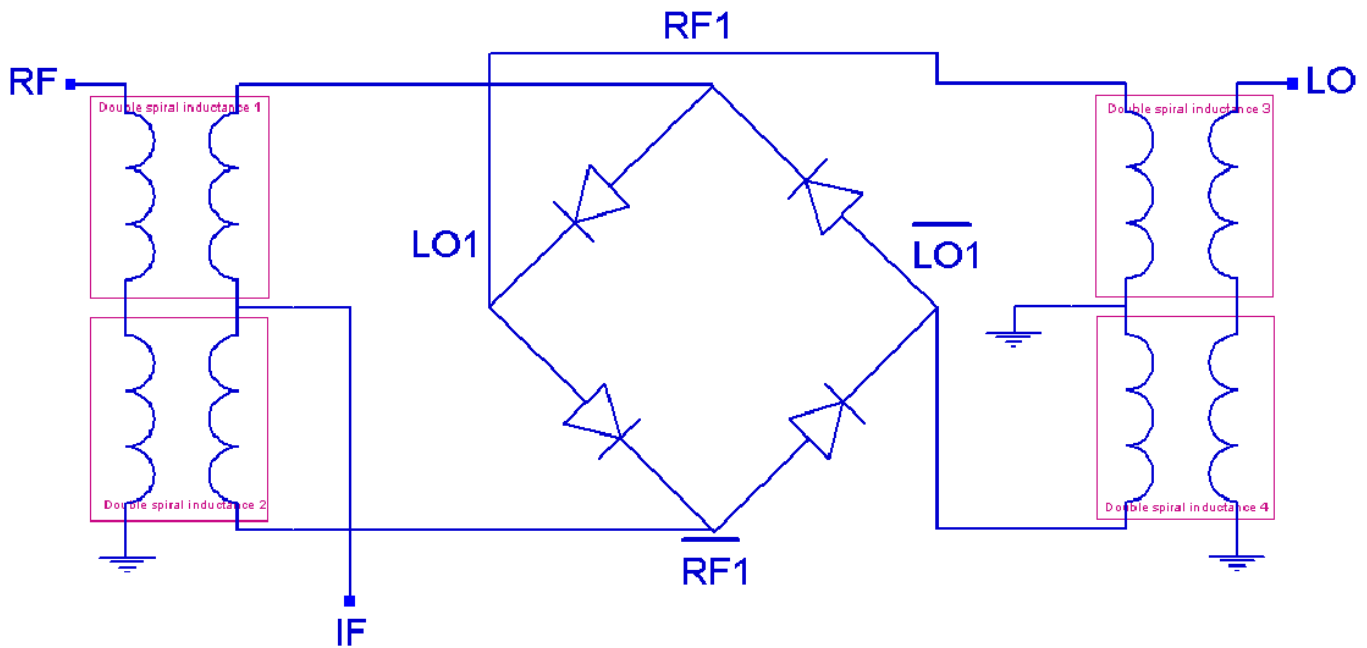

PAD POSITION

| PAD NAME | SYMBOL | COORDINATES | | DESCRIPTION |
|----------|--------|-------------|------|------------------------|
| | | X | Y | |
| LO | LO | 460 | 1353 | Local Oscillator Input |
| RF | RF | 460 | 112 | RF Input |
| IF | IF | 1353 | 689 | IF Output |

X=0, Y=0 at bottom left corner.

Co-ordinates correspond to the Centre of the Bonding Pad.

See Mechanical Information for more details.

BONDING DIAGRAM AND ASSEMBLY INFORMATION

The bonding wires should be gold and be as short as possible. The CGY2182UH uses through substrate via holes to obtain excellent RF grounding. The backside of the MMIC must be appropriately connected to the system ground.

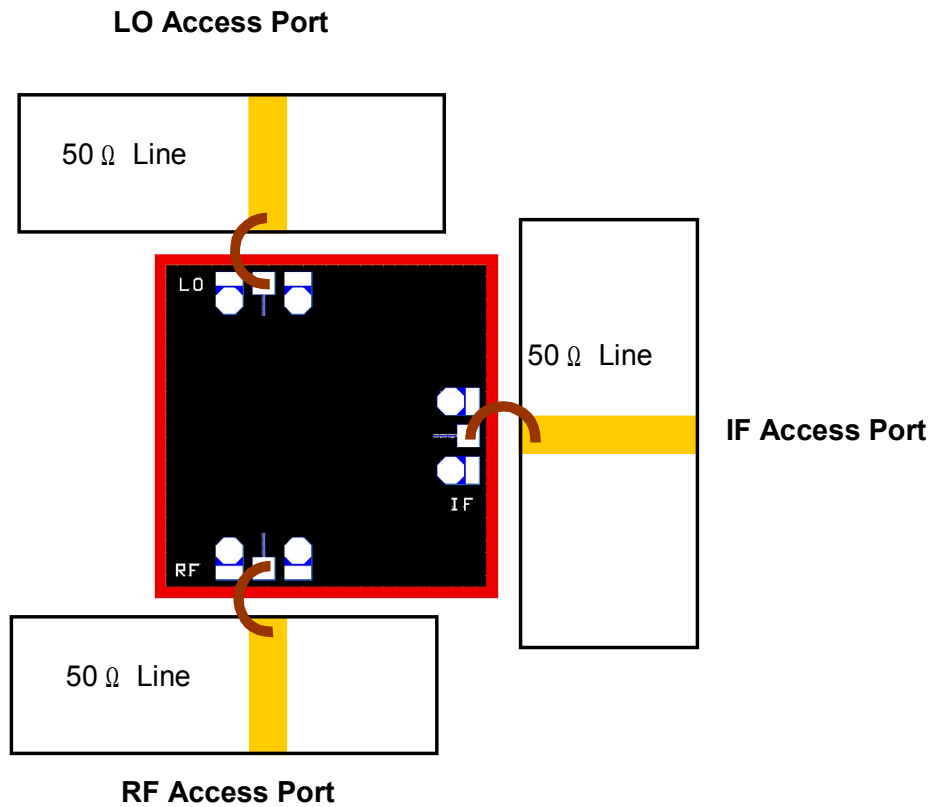

DEFINITIONS

Limiting values definition

Limiting values given are in accordance with the Absolute Maximum Rating System (IEC 60134). Stress above one or more of the limiting values may cause permanent damage to the device. These are stress ratings only and operation of the device at these or at any other conditions above those given in the Characteristics sections of the specification is not implied. Exposure to limiting values for extended periods may affect device reliability.

Application information

Applications that are described herein for any of these products are for illustrative purposes only. OMMIC makes no representation or warranty that such applications will be suitable for the specified use without further testing or modification.

DISCLAIMERS

Life support applications

These products are not designed for use in life support appliances, devices, or systems where malfunction of these products can reasonably be expected to result in personal injury. OMMIC's customers using or selling these products for use in such applications do so at their own risk and agree to fully indemnify OMMIC for any damages resulting from such application.

Right to make changes

OMMIC reserves the right to make changes, without notice, in the products, including circuits, standard cells, and/or software, described or contained herein in order to improve design and/or performance. OMMIC assumes no responsibility or liability for the use of any of these products, conveys no licence or title under any patent, copyright, or mask work right to these products, and makes no representations or warranties that these products are free from patent, copyright, or mask work right infringement, unless otherwise specified.

ORDERING INFORMATION

| Generic type | Package type | Version | Sort type | Description |
|--------------|--------------|---------|-----------|--|
| CGY2182 | UH | C1 | - | Double Balanced Quad Mixer MMIC |
| CGY2182 | GS | C1 | - | Hermetically Packaged Double Balanced Quad Mixer |



Document History : Version 1.0, Last Update 22/05/2012